

Z510

LED pendant light fittings

pendant light fitting with electronic control gear • control gear option • housing of aluminium profile • colour option • optional smooth opal or opal microprismatic diffuser made of PMMA • rated median operational life-time of luminaire 50 000h L70/B50 at Ta = 25°C • Standard Deviation Colour Matching MacAdam 3-step • suspension ordered separately

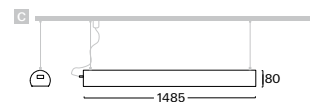

A3

Order code	Pict.	Power	Flux	Tc	Ra	kg
Z510cLWI.184H/..	c	1 x 84 W	12 090 lm	3000 K	≥ 80	3,8
Z510cLCI.184H/..	c	1 x 84 W	12 810 lm	4000 K	≥ 80	3,8
Z510cLDI.184H/..	c	1 x 84 W	13 170 lm	5000 K	≥ 80	3,8

Suspension necessary (ordered separately, see Accessories)

Max. number of luminaires in line is 6pcs for one 230V supply

Higher colour rendering index value - CRI

M

Example of order code assembly: Ra ≥90

[Z510cMDI.184H/A3.D3](#)

Dimmable version

A / D

Example of order code assembly: dimmable DALI

[Z510cLWD.184H/A3.D3](#)

Emergency version

N / H / F / G

Example of order code assembly: emergency operation

[Z510cLWIN.184H/A3.D3](#)



LED plate

- W3
- S3
- D3
- B3



230V-50Hz

PDF Optional types of glasses



A3
acrylic



M3
microprisma

Example of order code assembly:

opal acrylic diffuser

[Z510cLWI.184H/A3.D3](#)

PDF Accessories



SP
page 2



SP-H
page 2



SS
page 2



SSWD2
page 2



SU
page 2

ACCESSORIES

pendant linear luminaires



SSWD2 two-string adjustable suspension with lower lock

Order code	For light fittings	A
SSWD2x20	Z510	2m
SSWD2x50	Z510	5m

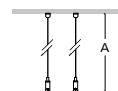

Example of order code assembly: [length 2m](#)

SSWD2x20

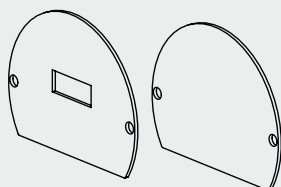

SU set of outer covers

Order code	For light fittings
SU-510	Z510

Example of order code assembly: [colour of the cover - silver](#)

SU-510.S1

Set includes: 1pce outer cover with screws
1pce outer cover for feed and screws

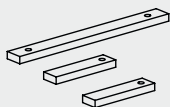

SS set of connectors

Order code	For light fittings
SS-510	Z510

Set includes: 1pce longer linear clutch with screws
2pcs linear clutch with crews

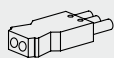

SP-H connective set for suspension

Order code	For light fitting
SP-H	Z510

Set includes: [plug connector for two calbes](#)

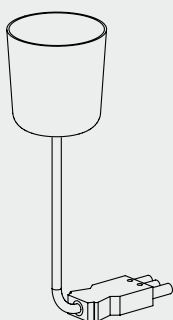

SP connective set with ceiling cup and suspension

Order code	For light fittings	A
SP-20H-KAP	Z510	2m
SP-50H-KAP	Z510	5m

Example of order code assembly: [colour of the ceiling cup - white](#)

SP-20H-KAP.W3

Set includes: [plug connector](#), [see-through cable](#), [ceiling cup with terminal block](#)

SETUP

linear pendant light fittings

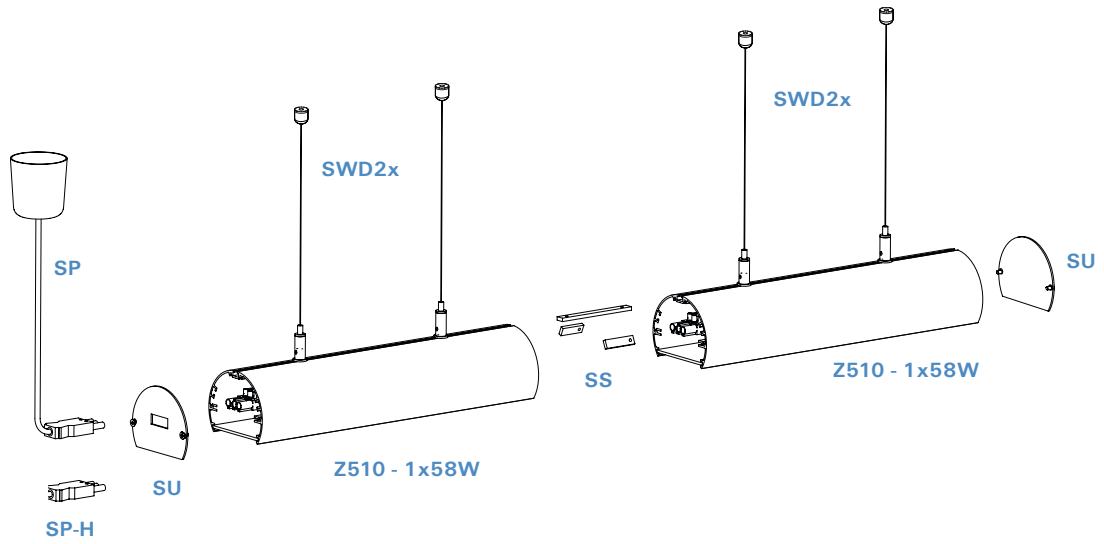

EXPLANATORY NOTES

for order code assembly

1	2	3	4	5	6	7	8	9	10	11			
V	299	s	LW	DN	.	124	A	/	HD	A3	.	W3	B

1	MOUNTING CATEGORY			2	PRODUCT CODE		3	CONFIGURATION OF LIGHT FITTING				
V	recessed	L	track	299	type marking of light fitting		s	control gear on cable (part of l. fitting)				
S	ceiling	Z	pendant	014	type marking of insert		c	control gear in luminaire (part of l. fitting)				
N	wall	C	insert of fitting	etc.			a	control gear in adapter (part of l. fitting)				
F	floor						r	control gear in rosette (part of l. fitting)				
							-	without control gear				
4	TYPE OF LIGHT SOURCE (SOCKET)											
Q0	LED PAR16 (GU10)			E2	LED A60, A65 (E27)		E2	LED PAR20, 30, 38 (E27)				
4a	TYPE OF LED LIGHT SOURCE			4b	CHROMATICITY OF LED SOURCE		4b	SPECTRUM OF LED SOURCE				
A	LED COIN 111 COB, COIN 111 AC Ra >80			I	warm white "interna" (2700 K)		R	spectrum for meat and sausages				
B	LED COIN 111 COB Ra >90			W	warm white (3000 K)		Y	spectrum for pastry, delicatessen and cheese				
F	LED COIN 50 COB Ra >80			B	white (3500 K)		F	spectrum for fish				
G	LED COIN 50 COB Ra >90			C	cool white (4000 K)		Z	spectrum for fruits and vegetables				
N	LED COIN 35 COB Ra >80			D	daylight white (5000 K)		A	spectrum for art (Ra>97)				
P	LED COIN 35 COB Ra >90			S	cool daylight (6500 K)		V	spectrum for clothing, fashion				
L	LED panel Ra >80			K	tunable white - commercial (2700 K-6500 K)		P	spectrum for plant growth				
M	LED panel Ra >90			T	dim to warm (dimming to warm chroma.)							
C	LED COB Ra >80											
D	LED COB Ra >90											
5	TYPE OF CONTROL GEAR						6	NUMBER AND OUTPUT OF LIGHT SOURCE				
	BASIC CONFIGURATION				EMERGENCY CONFIGURATION			NUMBER OF SOURCES, POWER OF FITTING				
I	non-dimmable constant current driver			N	emergency 1h		108	1 x 8 W				
U	non-dimmable constant voltage driver			H	emergency 3h		114	1 x 14 W				
A	dimmable analog 1-10V			F	emergency 1h with autotest		229	2 x 29 W				
D	dimmable DALI			G	emergency 3h with autotest		337	3 x 37 W				
S	dimmable DSI			Z	electronic address module		443	4 x 43 W				
C	dimmable with CORRIDOR function			P	central battery system							
T	dimmable using button 230V											
W	dimmable using push-button on luminaire											
L	phase dimmable											
X	dimmable Tunable white DALI											
B	dimmable Casambi (Bluetooth)											
7	TYPE OF REFLECTOR							TYPE OF DIFFUSER				
SS	super spot - beam angle <10°			MDG	medium - beam angle 21-34° (gold)		HD	smooth divided				
SP	spot - beam angle 10-20°			FLG	flood - beam angle 35-49° (gold)		HG	powder coated gold (G1)				
MD	medium - beam angle 21-34°			HU	smooth UGR < 19		SB	powder coated black sand (B3)				
FL	flood - beam angle 35-49°			MU	matt UGR < 19		SW	powder coated white sand (W3)				
WF	wideflood - beam angle ≥ 50°						xx	optional RAL colour				
8	TYPE OF COVER GLASS / FILTER							COLOUR OF COIN 111 COB COVER RING				
T1	tempered glass - clear			F4	blue filter		B	black				
T3	tempered glass - opal			F5	red filter		W	white				
A1	acrylic glass - clear			F6	green filter							
A3	acrylic glass - opal			F7	yellow filter							
M1	acrylic microprisma - clear			FH	honeycomb louvre							
M3	acrylic microprisma - opal			F9	linear spread lens*							
P1	acrylic prisma - clear				* for use with SP/MD reflector only							
9	COLOUR AND FINISH			10	SPECIAL VERSION							
W3	white sand interior/exterior			B	for assembly in concrete housing							
S3	silver sand interior			F	for assembly in facade insulation							
B3	black sand interior/exterior			KRP	for assembly in lamella ceilings							
D3	anthracite sand dark interior/exterior			P	for assembly in sheet metal ceilings							
xx	optional RAL colour											