

A series of white lines radiate from the top left towards the bottom right, creating a sense of depth and movement. The background is a dark blue gradient.

deos

DEOS.CZ, s.r.o., Na Slanici 379, 763 02 Zlín, Czech Republic
tel: +420 577 195 280, +420 577 195 283
info@deos.cz, deos@deos.cz

www.deos-lighting.com

www.deos.cz

© 2018



deos

LED 2018 | 19

deos

Světlo vytváří prostor
Light creates space

LED 2018 | 19

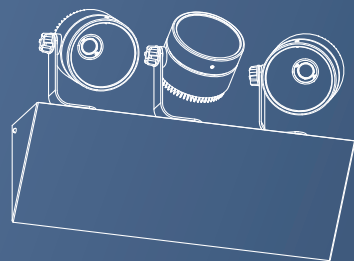
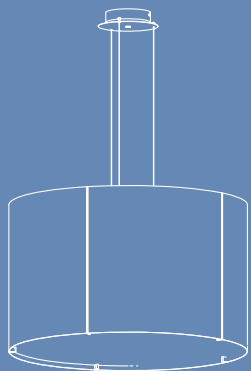
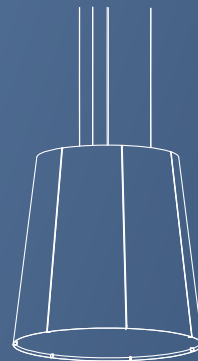
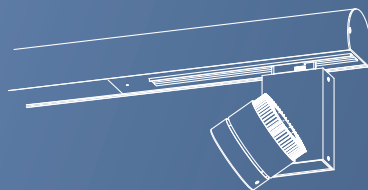
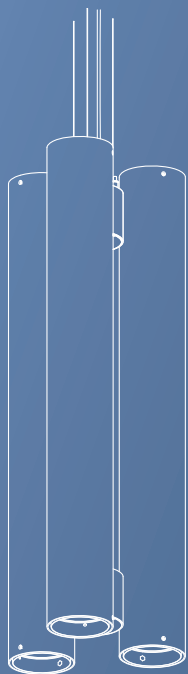
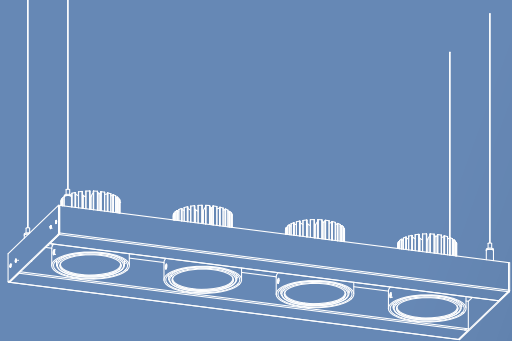

deos

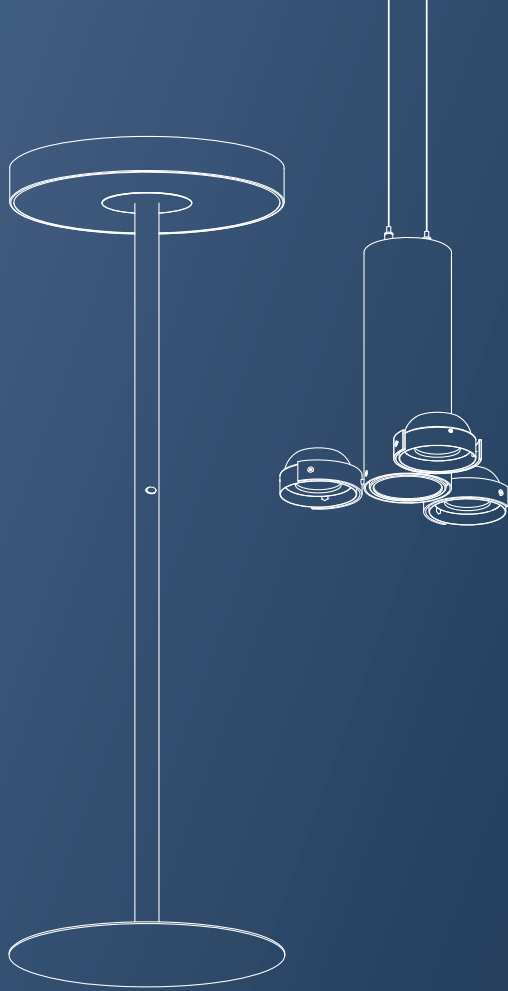

Společnost DEOS patří již 25 let k tradičním výrobcům interiérových svítidel v České republice. Od našeho vzniku jsme se specializovali zejména na moderní typy vestavných svítidel a postupně jsme produktovou řadu doplňovali o další typy výrobků. Na základě požadavků našich zákazníků sortiment dále rozšiřujeme o nové typy svítidel.

V současné době nabízíme zejména LED svítidla pro všeobecné osvětlování veřejných prostor a interiérů s využitím špičkových komponentů renomovaných výrobců (Osram, Citizen, BJB, Global Trac), která splňují i ta nejpřísnější kritéria.

Věříme, že s využitím aktuálních technologií, kreativního designu a precizního zpracování budou svítidla DEOS prostor nejen kvalitně osvětlovat, ale současně jej i vytvářet.

DEOS.CZ company has been a traditional producer of interior light fittings in the Czech Republic for 25 years. We have been specializing in modern recessed luminaires since our establishment and the product range has been gradually expanding with the addition of more types of products.

Currently we offer mostly LED light fittings for general illumination of public spaces and interiors using top-quality components made by renowned producers (Osram, Citizen, BJB, Global Trac) that meet the strictest criteria.

We believe that thanks to the use of the latest technology, creative design and perfect processing the DEOS light fittings will not only provide the space with high-quality illumination but also create the space itself.

V tomto katalogu vám představujeme přehled LED svítidel naší současné produkce. Najdete zde svítidla pro široké spektrum použití. Mnoho z těchto svítidel vzniklo ve spolupráci s architekty nebo našimi partnery dle jejich individuálních požadavků. Aktuální nabídku svítidel včetně všech doplňků a příslušenství naleznete na našich webových stránkách.

Jsme přesvědčeni, že s použitím nejnovějších LED technologií a kvalitního provedení budou svítidla DEOS i nadále zárukou té nejvyšší kvality.

This catalogue presents a selection of LED light fittings from our current production. Here you will find luminaires for wide range of applications. Many of these light fittings were created on request in cooperation with architects and our partners. To see the complete range of our luminaires and accessories please visit our webpage.

We believe that by using the latest LED technology and precise processing the DEOS company will continue to deliver the top-quality products.









Pro každý interiér a dokonalé sladění svítidel a prostoru nabízíme výrobky v řadě barevných provedení i povrchů, uvedených v našem vzorníku.

Svítidla jsou lakována práškovou metodou, která zaručuje vysokou odolnost proti mechanickému poškození a barevnou stálost.

Kromě barvy pláště je u některých svítidel možné zvolit také barvu reflektoru a vytvořit tak řadu barevných kombinací dle individuálních požadavků.

For every interior and seamless interconnection of light and space, we produce our light fittings in a number of colours and finishes presented in our colour catalogue.

Light fittings are powder coated. This method guarantees high resistance to surface damage and colour stability.

Apart from the colour of the housing you can choose also the colour of the reflector for some luminaires. This way you can create endless colour combinations and fine-tune luminaires down to the last detail.

Lištová svítidla /
Light fittings for tracks



L135 14



L305 41



L313 36



L314 18



L315 24



L316 35



L510 70



L511 73

Vestavná svítidla /
Recessed light fittings



V135 16



V191 50



V192 50



V193 50



V194 50



V313 37



V314 22



V315 26



V718 49



V755 46



V159 142



V160 145



V161 146



V181 149



V189 142



V190 145



V225 151



V277 151



V595 162



V600 162



V625 162



V130 126

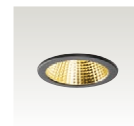

V131 126



V170 132



V213 134



V218 137



V299 138



V274 140



V821 121

Stropní svítidla / Ceiling light fittings



S135 14



S313 38



S305 45



S314 23



S315 24



S316 32



S225 156



S277 156



S300 152



S400 152

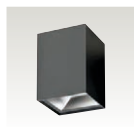

S160 158



S415 57



S416 159



S481 161



S510 67



S218 137



S299 138



S274 141



S800 83



S801 91



S802 97



S602/4 102



S606 109



S609 109



S614 105

Nástěnná svítidla / Wall light fittings

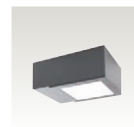

N225 155



N277 155



N307 100



N315 28



N415 58



N493 63



N510 68



N800 87



N801 95



N802 99



S300 152



S400 152



S602 102



S604 102



S614 105

Závěsná svítidla / Pendant light fittings



Z492 60



Z493 60



Z494 60



Z510 66



Z520 65



S602 102



S604 102



S606 109



S609 109



S614 105



Z646 111



Z648 111



Z686 114

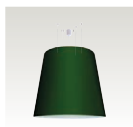

Z688 114



Z800 82



Z801 91



Z802 97



Z803 78



Z804 78



Z805 80



Z810 117



Z812 122



Z821 118



Z822 125



Z832 76



Z833 75



Z834 76

Vestavná s boxem / Built-in with box



D135 17



D313 37



D314 21



D315 27

Volně stojící svítidla / Free-standing light fittings



F604 106

Všechna svítidla v tomto katalogu jsou standardní výrobky. Na přání zákazníka je však možné tyto výrobky modifikovat, případně vytvořit nový typ svítidla pro konkrétní projekt.

Naše výrobky jsou ve shodě podle evropských norem (EN 60598) a na všechna svítidla byla vydána „Prohlášení o shodě“.

Světelný tok LED zdrojů uvedený u svítidel platí pro CCT = 4000K a CRI ≥ 80

Pro všechna svítidla v katalogu platí dále následující:

Střední dimenzovaná životnost svítidel 50 000h minimálně L70/B50 při Ta = 25°C (vyjma LED COIN 111 AC = 35 000h)

Standardní teplota chromatičnosti 3000, 4000, 5000K (možno 2700-6500K)

Standardní index barevného podání CRI ≥ 80 (možno CRI ≥ 90, CRI ≥ 97)

Barevná odchylka MacAdam 3SDCM (vyjma LED COIN 111, LED COIN 111 AC = 4SDCM)

LED zdroje jsou citlivé na působení elektrostatických výbojů a mechanické poškození - není vhodné se jich dotýkat.



Technické parametry svítidel odpovídají stavu v okamžiku předání do tisku a mohou se měnit. Výrobce si vyhrazuje právo na změny bez předchozího upozornění.

All luminaires in this catalogue are standard products, however those products can be modified on customer's request or new type of luminaire for specific project can be created.

Our products are in conformity with european standards (EN 60598) and on luminaires has been issued the EC-declaration of conformity.

Luminous flux of LED sources given for each luminaire applies for CCT = 4000K and CRI ≥ 80

For all luminaires in this catalogue applies following:

Rated median operational life-time of luminaires 50 000h min.

L70/B50 at Ta = 25°C (except for LED COIN 111 AC = 35 000h)

Standard correlated colour temperature 3000, 4000, 5000K (available 2700-6500K)

Standard colour rendering index CRI ≥ 80 (available CRI ≥ 90, CRI ≥ 97)

Standard Deviation Colour Matching MacAdam 3-step (except for LED COIN 111, LED COIN 111 AC = 4SDCM)

It is not suitable to touch the LED sources - they are sensitive to electrostatic discharge and mechanical damage.



Technical parameters of light fittings are correct at the time of printing and subject to change. The manufacturer reserves the right to change these without prior notice.

L135

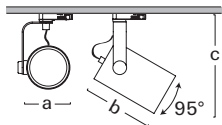

S135

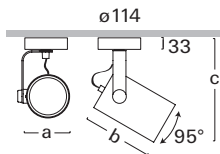

LED COIN 111 AC

16 W **1350** lm
23 W **1950** lm
∠ 24° / 40°
CCT 3000 / **4000** K
CRI **≥80**

LED retrofit

PAR16 60/83/150 (a/b/c)
PAR16/20 76/133/205 (a/b/c)
PAR30 114/137/235 (a/b/c)
PAR38 130/170/265 (a/b/c)
COIN 111 AC 114/140/235 (a/b/c)





SECTION

V135

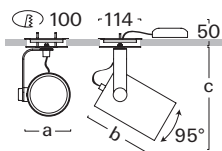

LED COIN 111

20 W **1560** lm
25 W **2500** lm
37 W **3780** lm

∠ 24° / 40°
CCT 2700 / 3000 / **4000** K
CRI **≥80** / ≥90

DIM

LED COIN 111 AC

16 W **1350** lm
23 W **1950** lm

LED retrofit

PAR16	60/83/150	(a/b/c)
PAR20	76/133/205	(a/b/c)
PAR30	114/137/235	(a/b/c)
PAR38	130/170/265	(a/b/c)
COIN 111 AC	114/140/235	(a/b/c)



D135

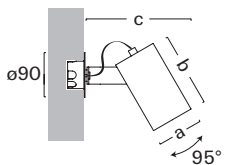

LED retrofit

PAR16	60/83/150	(a/b/c)
PAR20	76/133/205	(a/b/c)
PAR30	114/137/235	(a/b/c)
COIN 111 AC	114/140/235	(a/b/c)

LED COIN 111 AC

16 W	1350 lm
23 W	1950 lm
∠	24° / 40°
CCT	3000 / 4000 K
CRI	≥80



L314

LED cob

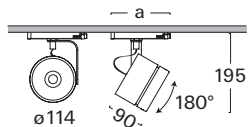

12 W	1600 lm	160	(a)
18 W	2220 lm	160	(a)
29 W	3400 lm	230	(a)
35 W	3900 lm	230	(a)

∠ SP / MD / FL / WF
CCT 3000 / **4000** / 5000 K
CRI **≥80** / ≥90

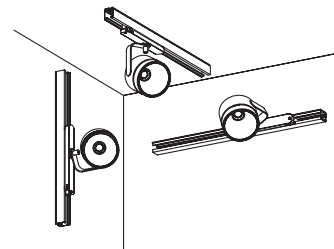

∠ FL

LED cob AC

9 W **800** lm

∠ SP / MD / FL / WF
CCT 2700 / **3000** K
CRI **≥80**

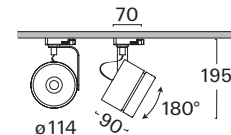





D314

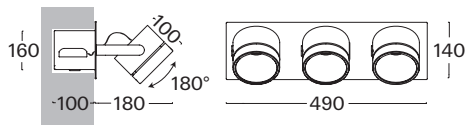
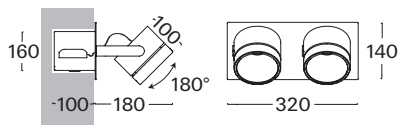
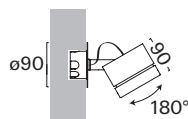
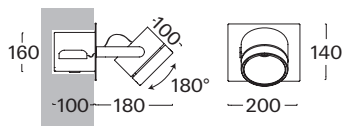

LED cob AC

9 W **800 lm**

◁ SP / MD / FL / WF
 CCT 2700 / **3000 K**
 CRI **≥80**



LED cob

10 W **1450 lm**
 14 W **2000 lm**
 20 W **2650 lm**
 29 W **3600 lm**
 37 W **4300 lm**
 43 W **5000 lm**

◁ SP / MD / FL / WF
 CCT 3000 / **4000** / 5000 K
 CRI **≥80 / ≥90**



V314

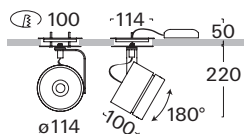

LED cob

10 W	1450 lm
14 W	2000 lm
20 W	2650 lm
29 W	3600 lm
37 W	4300 lm
43 W	5000 lm

◁ SP / MD / FL / WF
CCT 3000 / **4000** / 5000 K
CRI **≥80** / ≥90



LED cob AC

9 W **800** lm

◁ SP / MD / FL / WF
CCT 2700 / **3000** K
CRI **≥80**



◁ FL

S314

LED cob

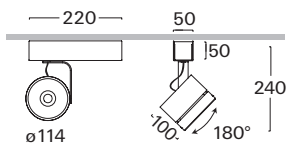

10 W	1450 lm	☒	SP / MD / FL / WF
14 W	2000 lm		CCT 3000 / 4000 / 5000 K
20 W	2650 lm		CRI ≥80 / ≥90
29 W	3600 lm		
37 W	4300 lm		
43 W	5000 lm		



LED cob AC

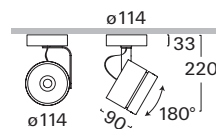

9 W	800 lm	☒	SP / MD / FL / WF
			CCT 2700 / 3000 K
			CRI ≥80

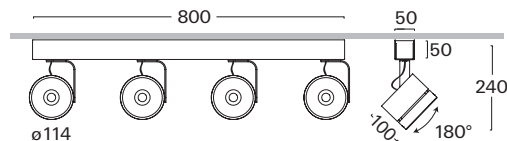
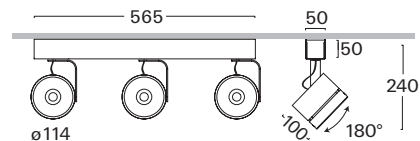
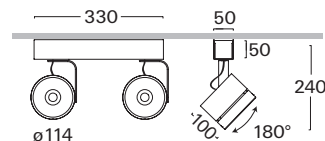

☒ FL



S315

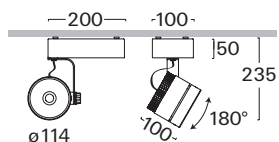

L315

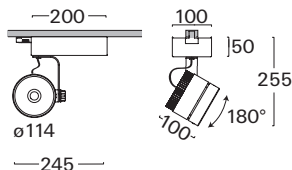

LED cob

10 W	1450 lm
14 W	2000 lm
20 W	2650 lm
29 W	3600 lm
37 W	4300 lm
43 W	5000 lm

◀ SP / MD / FL / WF
 CCT 3000 / **4000** / 5000 K
 CRI **≥80** / ≥90



LED cob AC

9 W **800** lm

◀ SP / MD / FL / WF
 CCT 2700 / **3000** K
 CRI **≥80**

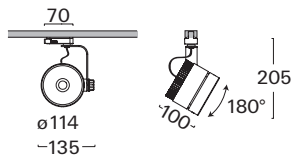
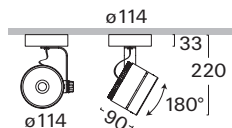



V315

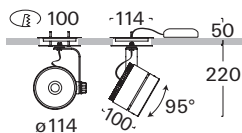

LED cob

10 W	1450 lm
14 W	2000 lm
20 W	2650 lm
29 W	3600 lm
37 W	4300 lm
43 W	5000 lm

☒ SP / MD / FL / WF
CCT 3000 / **4000** / 5000 K
CRI **≥80** / ≥90



LED cob AC

9 W **800** lm

☒ SP / MD / FL / WF
CCT 2700 / **3000** K
CRI **≥80**



☒ FL

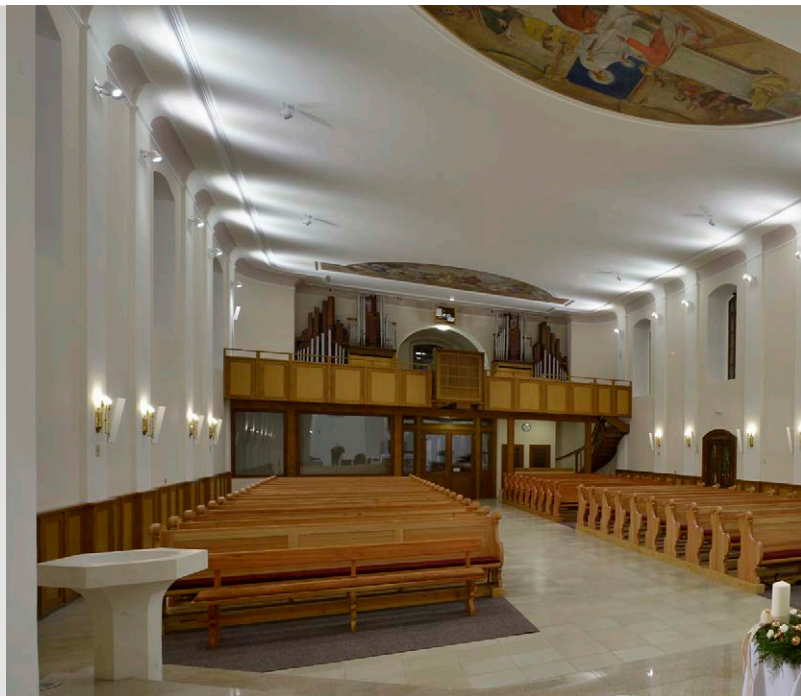

D315

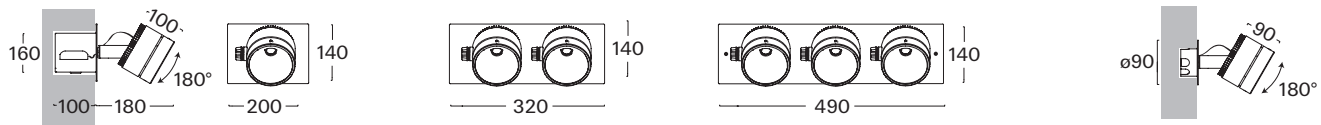

N315

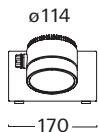
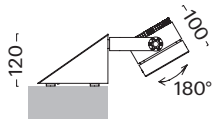
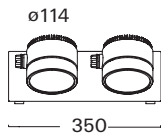
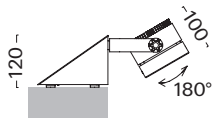
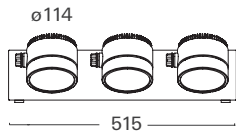
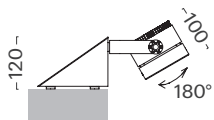

◁ FL

LED cob

10 W	1450 lm
14 W	2000 lm
20 W	2650 lm
29 W	3600 lm
37 W	4300 lm
43 W	5000 lm

◁	SP / MD / FL / WF
CCT	3000 / 4000 / 5000 K
CRI	≥80 / ≥90







N315

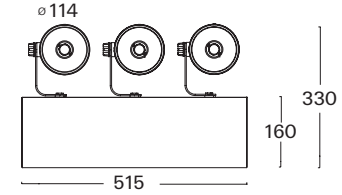
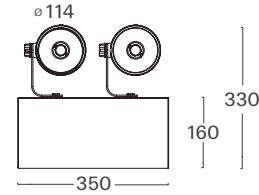
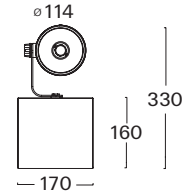
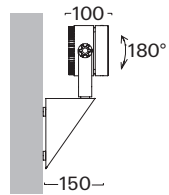

LED cob

10 W	1450 lm
14 W	2000 lm
20 W	2650 lm
29 W	3600 lm
37 W	4300 lm
43 W	5000 lm

\sphericalangle SP / MD / FL / WF
 CCT 3000 / **4000** / 5000 K
 CRI **≥ 80** / ≥ 90



S316

LED cob

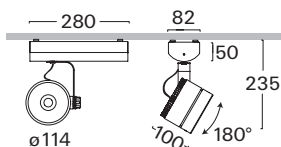

10 W	1450 lm
14 W	2000 lm
20 W	2650 lm
29 W	3600 lm
37 W	4300 lm
43 W	5000 lm

◁ SP / MD / FL / WF
CCT 3000 / **4000** / 5000 K
CRI **≥80** / ≥90



◁ FL

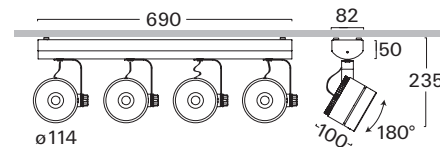
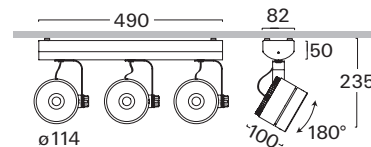
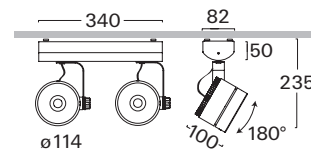





L316

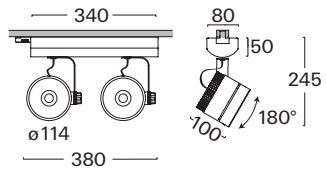
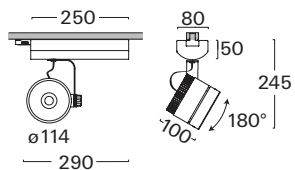

LED cob

10 W	1450 lm
14 W	2000 lm
20 W	2650 lm
29 W	3600 lm
37 W	4300 lm
43 W	5000 lm

☒ SP / MD / FL / WF
CCT 3000 / **4000** / 5000 K
CRI **≥80** / ≥90



☒ FL

L313

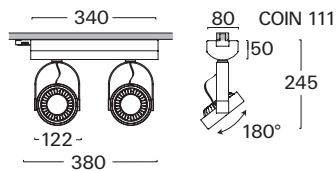
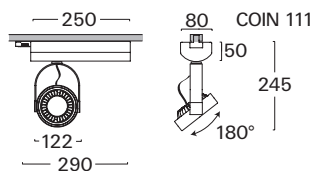
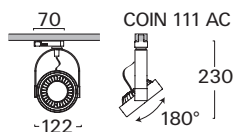

LED COIN 111

20 W **1560** lm
25 W **2500** lm
37 W **3780** lm

∠ 24° / 40°
CCT 2700 / 3000 / **4000** K
CRI **≥80** / ≥90

DIM

LED COIN 111 AC

16 W **1350** lm
23 W **1950** lm

∠ 24° / 40°
CCT 3000 / **4000** K
CRI **≥80**



V313

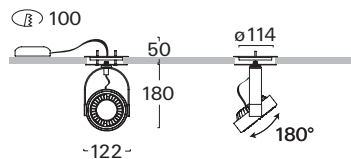

D313

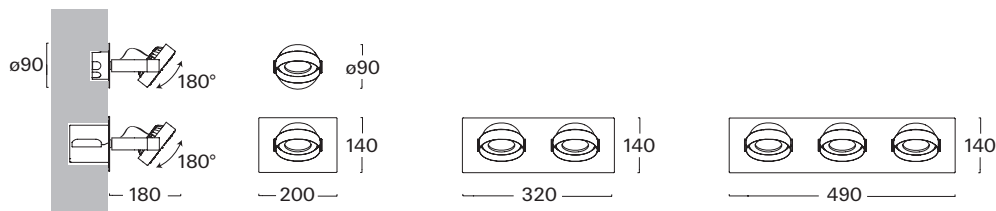

LED COIN 111

20 W **1560** lm
 25 W **2500** lm
 37 W **3780** lm



LED COIN 111 AC

16 W **1350** lm
 23 W **1950** lm

∠ 24° / 40°
 CCT 2700 / 3000 / **4000** K
 CRI **≥80** / ≥90



S313

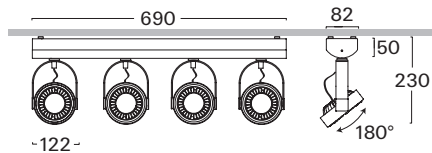
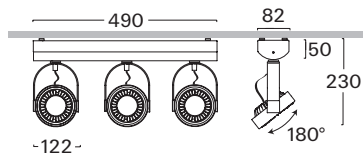
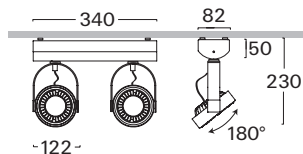
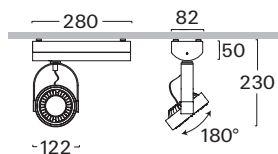

LED COIN 111

20 W **1560** lm
25 W **2500** lm
37 W **3780** lm

∠ 24° / 40°
CCT 2700 / 3000 / **4000** K
CRI **≥80** / ≥90

DIM

LED COIN 111 AC

16 W **1350** lm
23 W **1950** lm

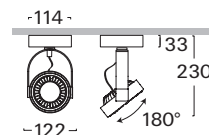





L305

LED cob

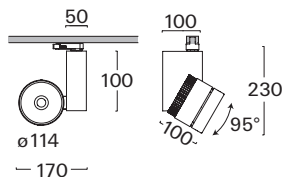

10 W	1450 lm
14 W	2000 lm
20 W	2650 lm
29 W	3600 lm
37 W	4300 lm
43 W	5000 lm

◁ SP / MD / FL / WF
CCT 3000 / **4000** / 5000 K
CRI **≥80** / ≥90

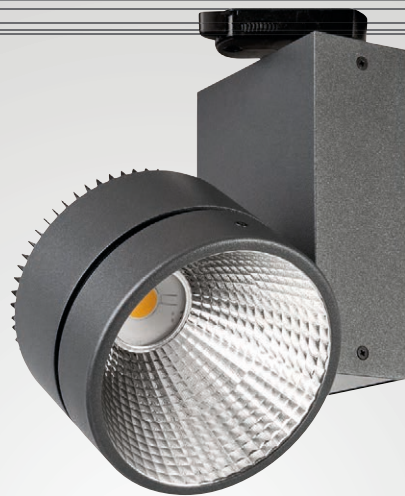

◁ FL









S305

LED cob

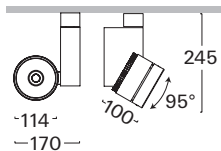

10 W	1450 lm
14 W	2000 lm
20 W	2650 lm
29 W	3600 lm
37 W	4300 lm
43 W	5000 lm

∠ SP / MD / FL / WF
CCT 3000 / **4000** / 5000 K
CRI **≥80** / ≥90



∠ FL



V755

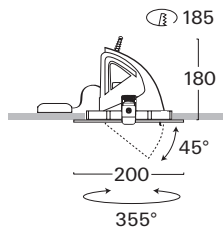

LED cob

10 W	1450 lm
14 W	2000 lm
20 W	2650 lm
29 W	3600 lm
37 W	4300 lm
43 W	5000 lm

☒ SP / MD / FL / WF
CCT 3000 / **4000** / 5000 K
CRI **≥80** / ≥90



☒ FL



1910 **Valera** 
SWISS HAIR SPECIALISTS



V718

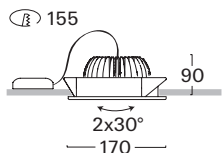
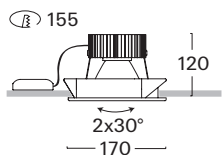

LED cob

10 W	1450 lm
14 W	2000 lm
20 W	2650 lm
29 W	3600 lm
37 W	4300 lm
43 W	5000 lm

∠ SP / MD / FL / WF
CCT 3000 / **4000** / 5000 K
CRI **≥80** / ≥90



LED COIN 111

20 W	1560 lm
25 W	2500 lm
37 W	3780 lm

DIM

LED COIN 111 AC

16 W	1350 lm
23 W	1950 lm

∠ 24° / 40°
CCT 2700 / 3000 / **4000** K
CRI **≥80** / ≥90



∠ FL

V191

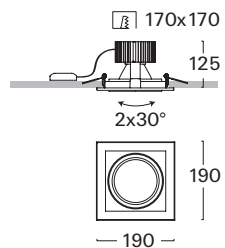

LED cob

10 W	1450 lm
14 W	2000 lm
20 W	2650 lm
29 W	3600 lm
37 W	4300 lm
43 W	5000 lm

◁ SP / MD / FL / WF
CCT 3000 / **4000** / 5000 K
CRI **≥80** / ≥90



V192

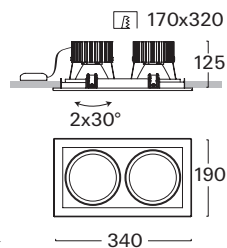

V193

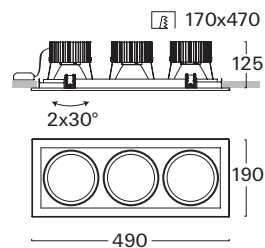

V194

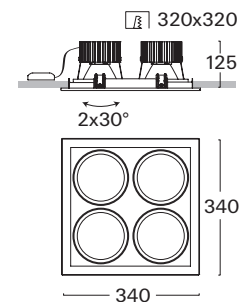

◁ MD





ŠKODA



NOVÁ
ŠKODA
FABIA

Fabia Combi

FABIA
Především vás

Октавия Комби

V191

LED COIN 111

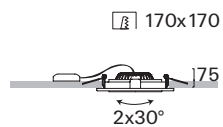

20 W **1560** lm
25 W **2500** lm
37 W **3780** lm

DIM

LED COIN 111 AC

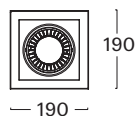

16 W **1350** lm
23 W **1950** lm

∠ 24° / 40°
CCT 2700 / 3000 / **4000** K
CRI **≥80** / ≥90

V192

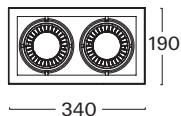
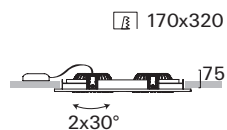

V193

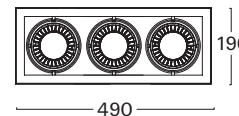
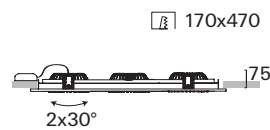

V194

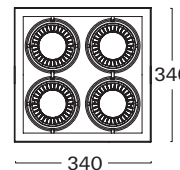
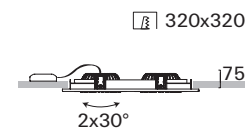







S415

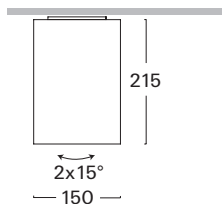

LED cob

10 W	1450 lm
14 W	2000 lm
20 W	2650 lm
29 W	3600 lm
37 W	4300 lm
43 W	5000 lm

☒ SP / MD / FL / WF
CCT 3000 / **4000** / 5000 K
CRI **≥80** / ≥90



LED COIN 111

20 W	1560 lm
25 W	2500 lm
37 W	3780 lm



LED COIN 111 AC

16 W	1350 lm
23 W	1950 lm

☒ 24° / 40°
CCT 2700 / 3000 / **4000** K
CRI **≥80** / ≥90



☒ FL

N415

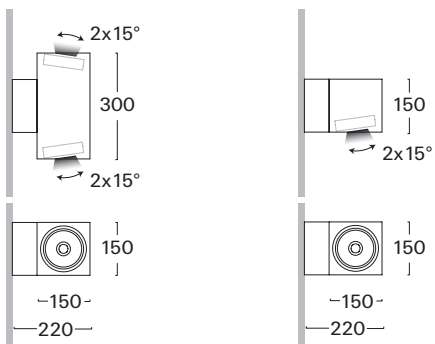

LED cob

10 W	1450 lm
14 W	2000 lm
20 W	2650 lm
29 W	3600 lm
37 W	4300 lm
43 W	5000 lm

◀ SP / MD / FL / WF
CCT 3000 / **4000** / 5000 K
CRI **≥80** / ≥90



◀ WF

N415

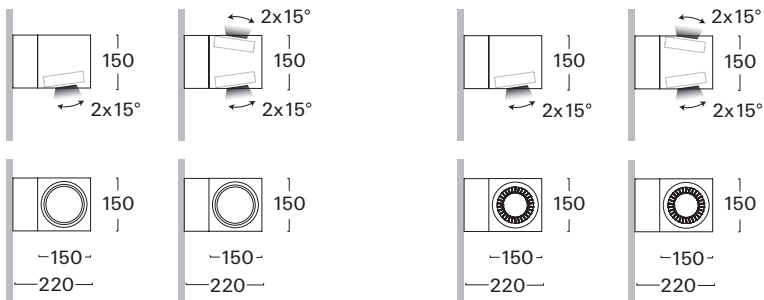

LED COIN 111

20 W **1560** lm
 25 W **2500** lm
 37 W **3780** lm

∠ 24° / 40°
 CCT 2700 / 3000 / **4000** K
 CRI **≥80** / ≥90

DIM

LED COIN 111 AC

16 W **1350** lm
 23 W **1950** lm

LED cob

10 W **1450** lm
 14 W **2000** lm
 20 W **2650** lm

CCT 3000 / **4000** / 5000 K
 CRI **≥80** / ≥90

DIM A3 P1 M3



A3

Z494

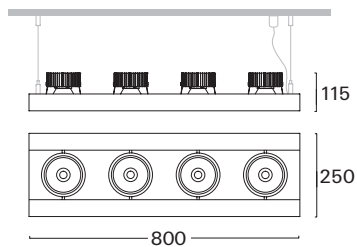

Z493

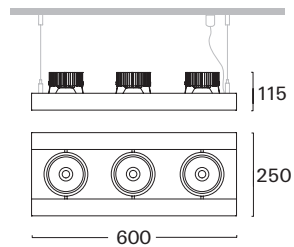

Z492

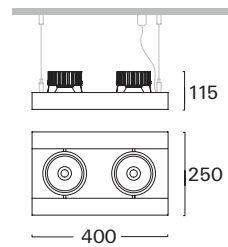

LED cob

10 W	1450 lm
14 W	2000 lm
20 W	2650 lm
29 W	3600 lm
37 W	4300 lm
43 W	5000 lm

☒	SP / MD / FL / WF
CCT	3000 / 4000 / 5000 K
CRI	≥80 / ≥90



TOYOTA **COROLLA**
LEGENDA JUŽ OD ROKU 1966

Vyhodíte si vlastní vůle



Nezastupitelná první komponenta pro novou Toyota

NOVA **COROLLA**
Přeměňte potřeby

Vítejte

„Žádám všechny, aby od
tého chvíle soustředili své
síly k dosažení společného
cíle: Vyrábět vždy lepší vozy.“

Shigeru Toyoda, 1939
předseda Toyota Motor Corporation

N493

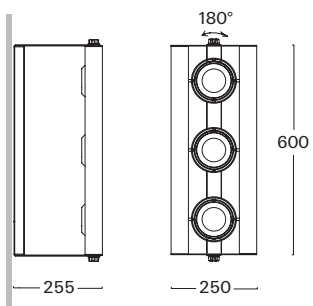

LED COIN 111

20 W **1560** lm
25 W **2500** lm
37 W **3780** lm

LED COIN 111 AC

16 W **1350** lm
23 W **1950** lm

∠ 24° / 40°
CCT 2700 / 3000 / **4000** K
CRI **≥80** / ≥90

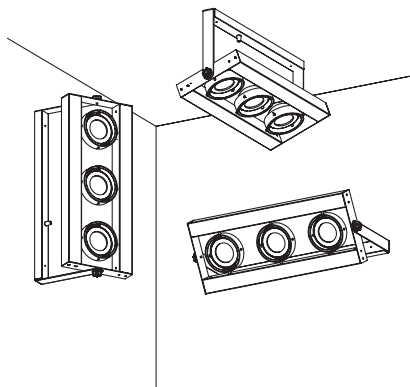



Z520

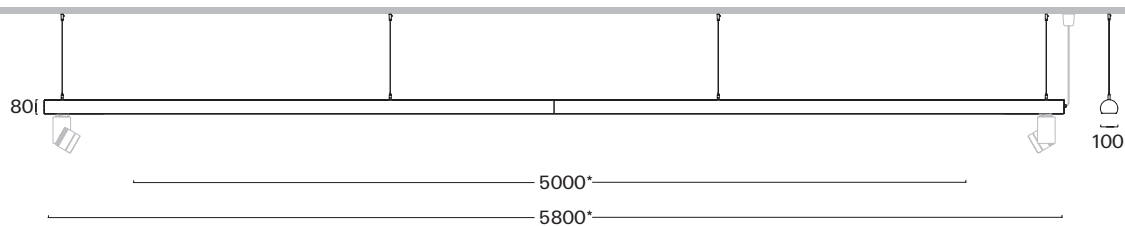

LED plate

76 W **9810** lm
160 W **17600** lm

CCT 3000 / **4000** / 5000 K
CRI **≥80** / ≥90



* jiný rozměr možný
* another size possible



Z510

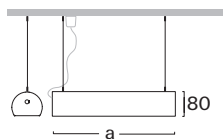

Z510 linear

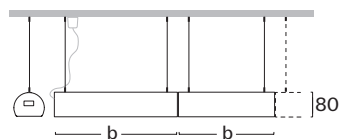

LED plate

20 W	2990 lm	250 (a)
28 W	4270 lm	500 (a)
40 W	5740 lm	500 (a)
56 W	8540 lm	1000 (a)
80 W	11480 lm	1000 (a)
84 W	12810 lm	1500 (a,b)

CCT 3000 / **4000** / 5000 K
CRI **≥80** / ≥90



A3

S510

LED plate

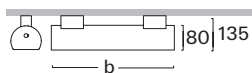
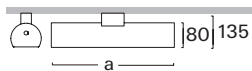

20 W	2990 lm	250 (a)
28 W	4270 lm	500 (a)
40 W	5740 lm	500 (a)
56 W	8540 lm	1000 (b)
80 W	11480 lm	1000 (b)
84 W	12810 lm	1500 (b)

CCT 3000 / **4000** / 5000 K

CRI **≥80** / ≥90

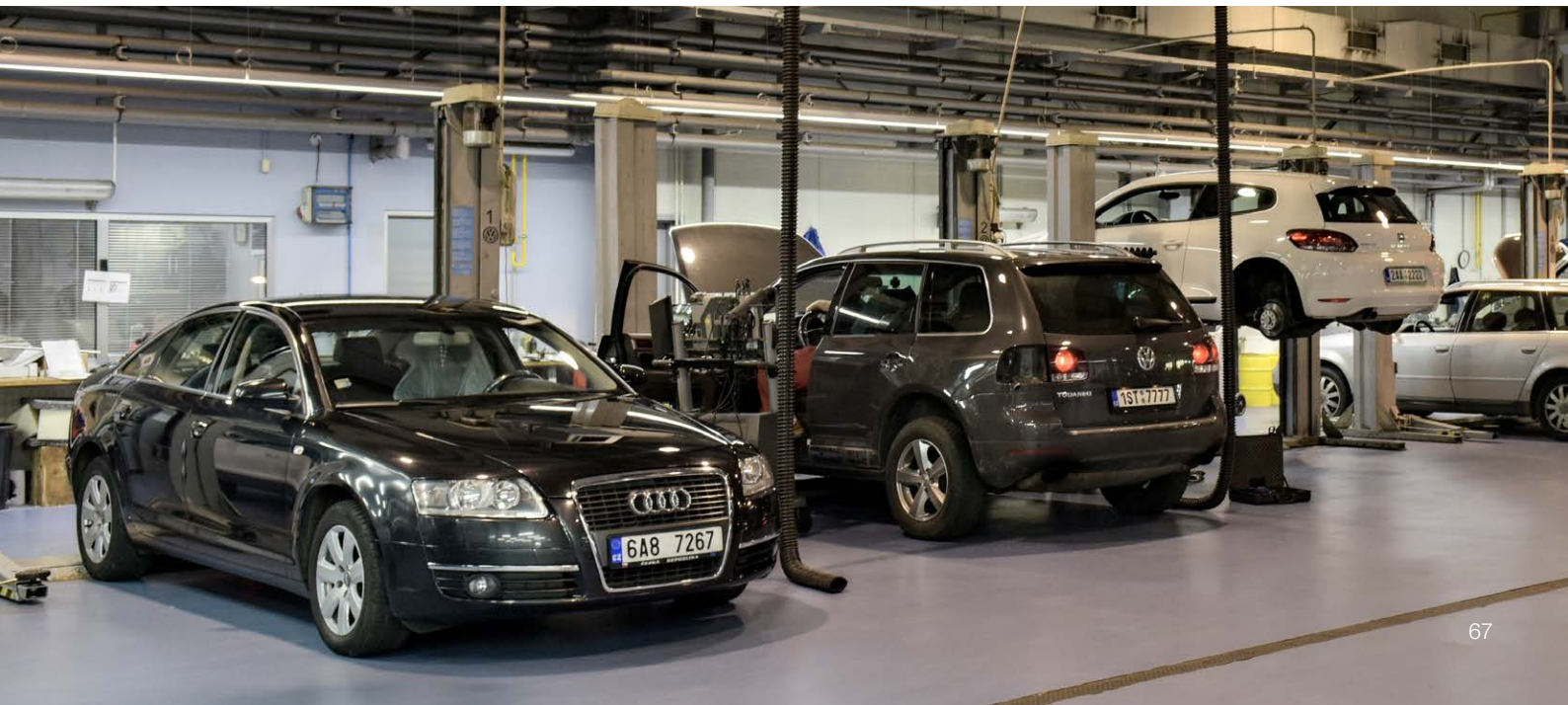

N510

LED plate

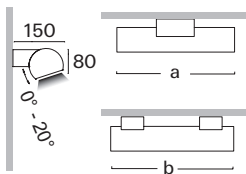

20 W	2990 lm	250 (a)
28 W	4270 lm	500 (a)
40 W	5740 lm	500 (a)
56 W	8540 lm	1000 (b)
80 W	11480 lm	1000 (b)

CCT 3000 / **4000** / 5000 K
CRI **≥80** / ≥90

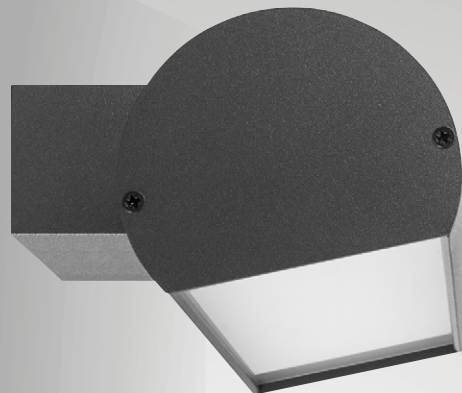

A3



POHODA PROSTŘEDÍ
ČISTÁ PITNÁ VODA

Komfortní úroveň
a náročnosti

ŘEŠENÍ PRO KAŽDÝ SYSTÉM

elements 

L510

LED plate

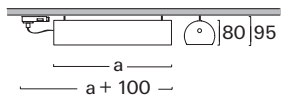

20 W	2990 lm	250 (a)
28 W	4270 lm	500 (a)
40 W	5740 lm	500 (a)
56 W	8540 lm	1000 (a)
80 W	11480 lm	1000 (a)

CCT 3000 / **4000** / 5000 K
CRI **≥80** / ≥90



A3





L511

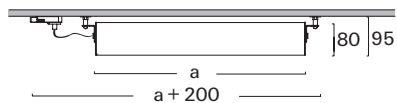

85° - 0° - 85°

LED plate

20 W	2990 lm	250 (a)
28 W	4270 lm	500 (a)
40 W	5740 lm	500 (a)
56 W	8540 lm	1000 (a)
80 W	11480 lm	1000 (a)

CCT 3000 / **4000** / 5000 K
CRI **≥80** / ≥90

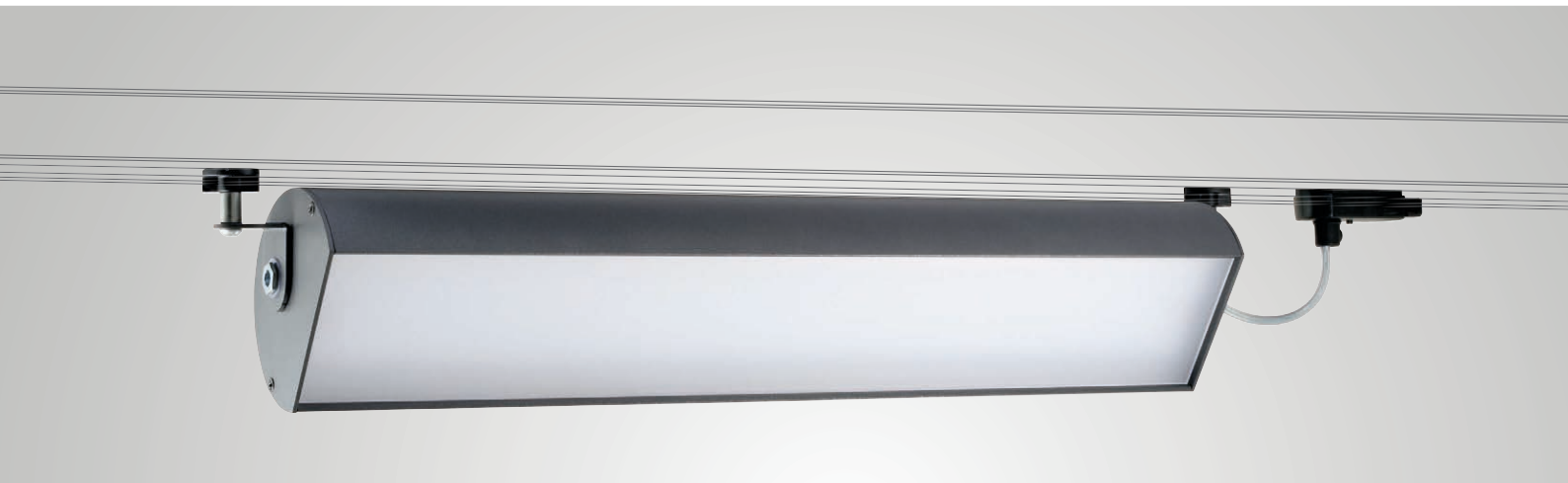

A3



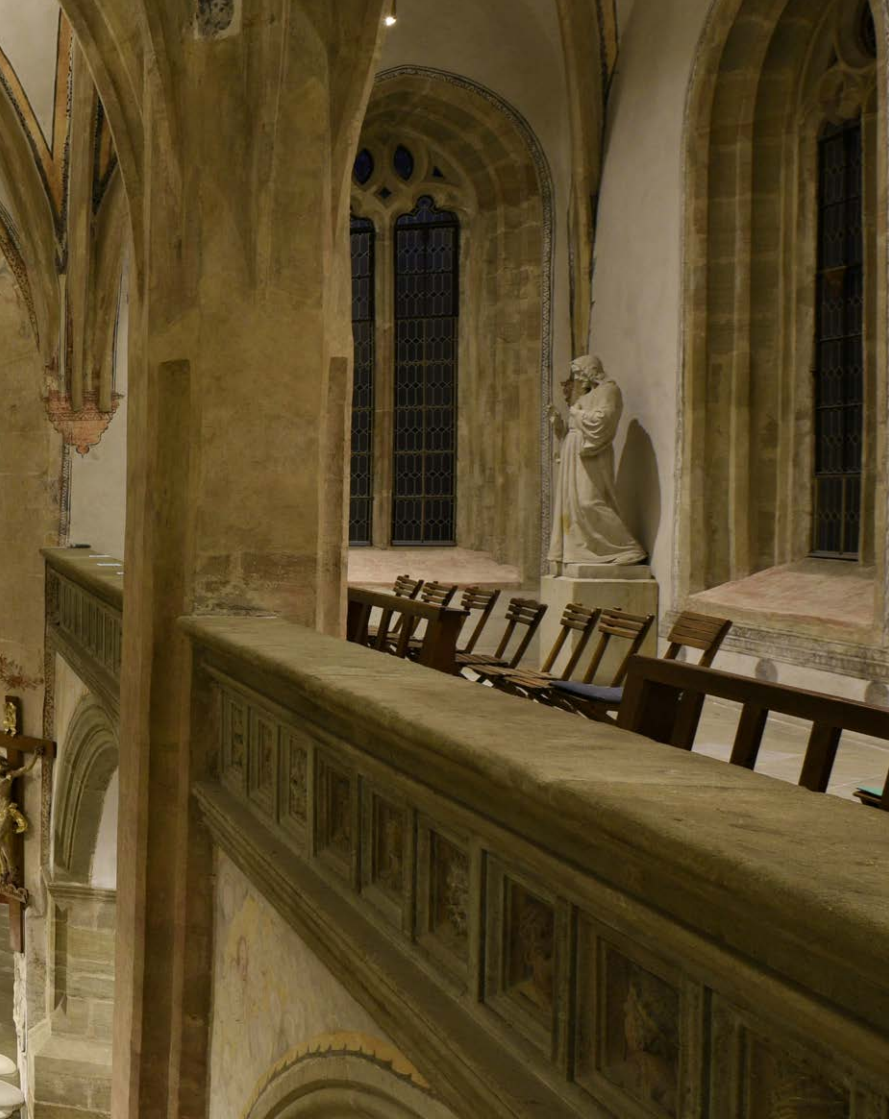

Z833

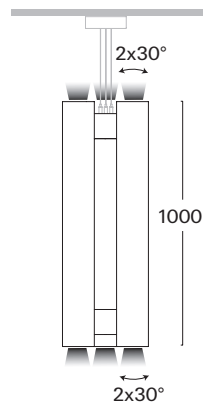

* jiný rozměr možný
* another size possible

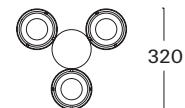

LED COIN 111

20 W **1560** lm
25 W **2500** lm
37 W **3780** lm

LED COIN 111 AC

16 W **1350** lm
23 W **1950** lm

∠ 24° / 40°
CCT 2700 / 3000 / **4000** K
CRI **≥80** / ≥90





Z832

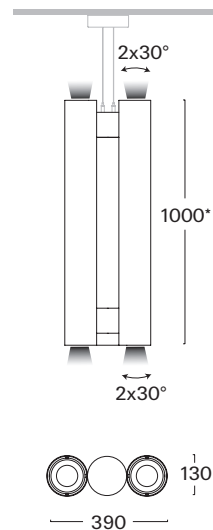

LED COIN 111

20 W **1560** lm
 25 W **2500** lm
 37 W **3780** lm

DIM

∠ 24° / 40°
 CCT 2700 / 3000 / **4000** K
 CRI **≥80** / ≥90



LED COIN 111 AC

16 W **1350** lm
 23 W **1950** lm

* jiný rozměr možný
 * another size possible

Z834

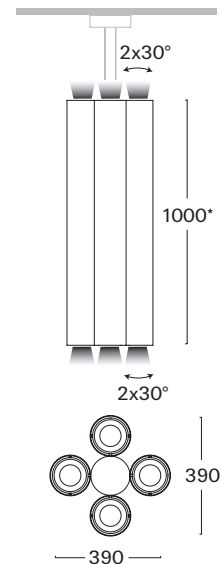



Z803

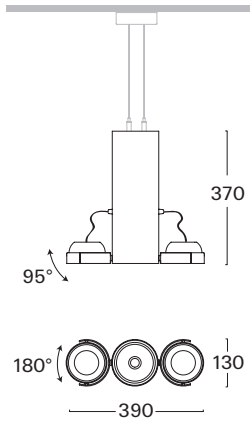

Z804

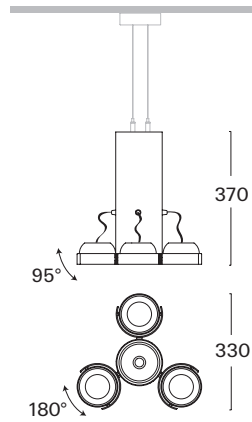

LED cob

10 W **1450** lm
14 W **2000** lm
20 W **2650** lm
29 W **3600** lm
37 W **4300** lm
43 W **5000** lm

☒ SP / MD / FL / WF
CCT 3000 / **4000** / 5000 K
CRI **≥80** / ≥90



LED COIN 111 AC

16 W **1350** lm
23 W **1950** lm

☒ 24° / 40°
CCT 3000 / **4000** K
CRI **≥80**



Z805

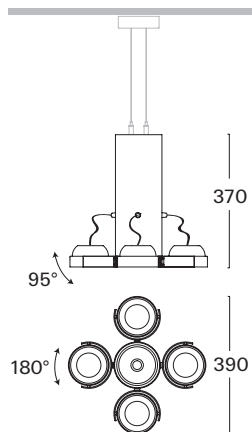

LED cob

10 W	1450 lm
14 W	2000 lm
20 W	2650 lm
29 W	3600 lm
37 W	4300 lm
43 W	5000 lm

∠	SP / MD / FL / WF
CCT	3000 / 4000 / 5000 K
CRI	≥80 / ≥90



LED COIN 111 AC

16 W	1350 lm
23 W	1950 lm

∠	24° / 40°
CCT	3000 / 4000 K
CRI	≥80





Z800

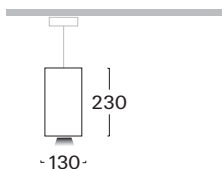

LED cob

10 W **1450** lm
14 W **2000** lm
20 W **2650** lm
29 W **3600** lm

☒ SP / MD / FL / WF
CCT 3000 / **4000** / 5000 K
CRI **≥80** / ≥90



LED cob AC

9 W **800** lm

☒ SP / MD / FL / WF
CCT 2700 / **3000** K
CRI **≥80**

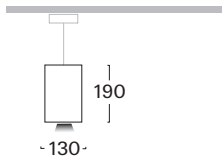

LED cob

10 W **1450** lm
14 W **2000** lm
20 W **2650** lm

CCT 3000 / **4000** / 5000 K
CRI **≥80** / ≥90



LED cob AC

9 W **800** lm

☒ SP / MD / FL / WF
CCT 2700 / **3000** K
CRI **≥80**



☒ FL

S800

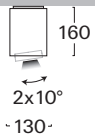
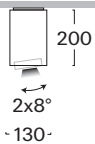

Z800

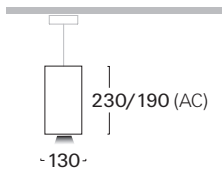

S800

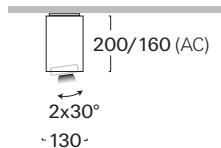

LED COIN 111

20 W **1560** lm
25 W **2500** lm



LED COIN 111 AC

16 W **1350** lm
23 W **1950** lm

∠ 24° / 40°
CCT 2700 / 3000 / **4000** K
CRI **≥80** / ≥90





Baltacı



N800

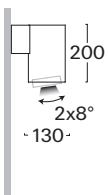

LED cob

10 W **1450** lm
14 W **2000** lm
20 W **2650** lm
29 W **3600** lm

DIM

LED cob AC

9 W **800** lm

⊲ SP / MD / FL / WF
CCT 2700 / 3000 / **4000** K
CRI **≥80** / ≥90



⊲ FL

N800

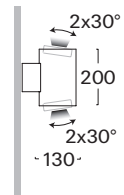
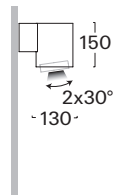

LED COIN 111 AC

16 W **1350** lm

23 W **1950** lm

∠ 24° / 40°

CCT 3000 / **4000** K

CRI **≥80**



N800

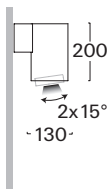

LED cob

10 W **1450** lm

14 W **2000** lm

20 W **2650** lm

CCT 2700 / 3000 / **4000** K

CRI **≥80** / ≥90



LED cob AC

9 W **800** lm

CCT 2700 / **3000** K

CRI **≥80**



Corral
mody a šperky



Valentýn 142

CITIZEN

-50%

-70%

-30%

POLICE

POLICE

ESPRIT

Valentýn 142

DKNY

DKNY

DKNY

S801

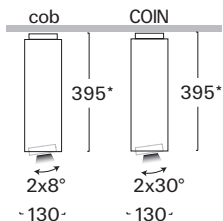

LED cob

10 W	1450 lm
14 W	2000 lm
20 W	2650 lm
29 W	3600 lm
37 W	4300 lm
43 W	5000 lm

⚡ SP / MD / FL / WF
CCT 3000 / **4000** / 5000 K
CRI **≥80** / ≥90



* větší rozměr možný
* bigger size possible

Z801

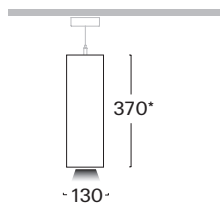

LED COIN 111

20 W	1560 lm
25 W	2500 lm
37 W	3780 lm

DIM

LED COIN 111 AC

16 W	1350 lm
23 W	1950 lm

⚡ 24° / 40°
CCT 2700 / 3000 / **4000** K
CRI **≥80** / ≥90



⚡ WF



LUSSO CAFFÈ
TAVOLINO
Cappuccino 1,50 €
Cappuccino 2,00 €
Cappuccino 2,50 €
Cappuccino 3,00 €
Cappuccino 3,50 €
Cappuccino 4,00 €
Cappuccino 4,50 €
Cappuccino 5,00 €
Cappuccino 5,50 €
Cappuccino 6,00 €
Cappuccino 6,50 €
Cappuccino 7,00 €
Cappuccino 7,50 €
Cappuccino 8,00 €
Cappuccino 8,50 €
Cappuccino 9,00 €
Cappuccino 9,50 €
Cappuccino 10,00 €
Cappuccino 10,50 €
Cappuccino 11,00 €
Cappuccino 11,50 €
Cappuccino 12,00 €
Cappuccino 12,50 €
Cappuccino 13,00 €
Cappuccino 13,50 €
Cappuccino 14,00 €
Cappuccino 14,50 €
Cappuccino 15,00 €
Cappuccino 15,50 €
Cappuccino 16,00 €
Cappuccino 16,50 €
Cappuccino 17,00 €
Cappuccino 17,50 €
Cappuccino 18,00 €
Cappuccino 18,50 €
Cappuccino 19,00 €
Cappuccino 19,50 €
Cappuccino 20,00 €
Cappuccino 20,50 €
Cappuccino 21,00 €
Cappuccino 21,50 €
Cappuccino 22,00 €
Cappuccino 22,50 €
Cappuccino 23,00 €
Cappuccino 23,50 €
Cappuccino 24,00 €
Cappuccino 24,50 €
Cappuccino 25,00 €
Cappuccino 25,50 €
Cappuccino 26,00 €
Cappuccino 26,50 €
Cappuccino 27,00 €
Cappuccino 27,50 €
Cappuccino 28,00 €
Cappuccino 28,50 €
Cappuccino 29,00 €
Cappuccino 29,50 €
Cappuccino 30,00 €
Cappuccino 30,50 €
Cappuccino 31,00 €
Cappuccino 31,50 €
Cappuccino 32,00 €
Cappuccino 32,50 €
Cappuccino 33,00 €
Cappuccino 33,50 €
Cappuccino 34,00 €
Cappuccino 34,50 €
Cappuccino 35,00 €
Cappuccino 35,50 €
Cappuccino 36,00 €
Cappuccino 36,50 €
Cappuccino 37,00 €
Cappuccino 37,50 €
Cappuccino 38,00 €
Cappuccino 38,50 €
Cappuccino 39,00 €
Cappuccino 39,50 €
Cappuccino 40,00 €
Cappuccino 40,50 €
Cappuccino 41,00 €
Cappuccino 41,50 €
Cappuccino 42,00 €
Cappuccino 42,50 €
Cappuccino 43,00 €
Cappuccino 43,50 €
Cappuccino 44,00 €
Cappuccino 44,50 €
Cappuccino 45,00 €
Cappuccino 45,50 €
Cappuccino 46,00 €
Cappuccino 46,50 €
Cappuccino 47,00 €
Cappuccino 47,50 €
Cappuccino 48,00 €
Cappuccino 48,50 €
Cappuccino 49,00 €
Cappuccino 49,50 €
Cappuccino 50,00 €





N801

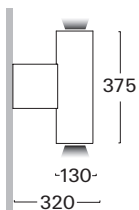

LED cob

10 W	1450 lm
14 W	2000 lm
20 W	2650 lm
29 W	3600 lm
37 W	4300 lm
43 W	5000 lm

◁ SP / MD / FL / WF
CCT 3000 / **4000** / 5000 K
CRI **≥80** / ≥90



LED COIN 111

20 W	1560 lm
25 W	2500 lm
37 W	3780 lm



LED COIN 111 AC

16 W	1350 lm
23 W	1950 lm

◁ 24° / 40°
CCT 2700 / 3000 / **4000** K
CRI **≥80** / ≥90



◁ FL

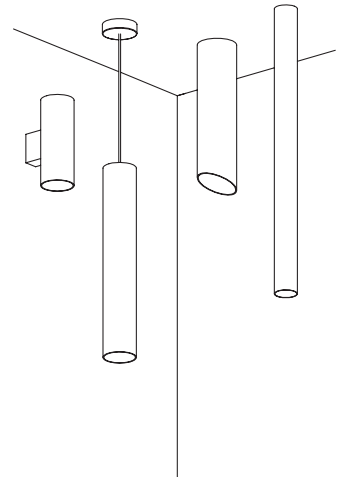

S802

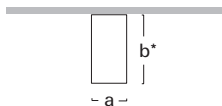

LED retrofit

PAR16	60/140/140	(a/b/c)
PAR16/20	76/180/140	(a/b/c)
PAR30	114/168/137	(a/b/c)
PAR38	130/217/190	(a/b/c)

COIN 50 AC	60/200/200	(a/b/c)
COIN 111 AC	114/140/140	(a/b/c)

Z802

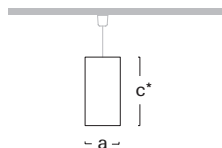

LED COIN 111 AC

16 W	1350 lm
23 W	1950 lm

∠	24° / 40°
CCT	3000 / 4000 K
CRI	≥80

- * větší rozměr možný
- * bigger size possible





N802

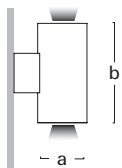

LED retrofit

PAR16	76/164/132	(a/b/c)
PAR16/20	76/250/145	(a/b/c)
PAR30	114/300/145	(a/b/c)
PAR38	130/380/180	(a/b/c)
COIN 111 AC	114/200/155	(a/b/c)

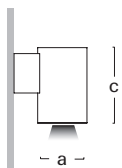

LED COIN 111 AC

16 W	1350 lm
23 W	1950 lm
∠	24° / 40°
CCT	3000 / 4000 K
CRI	≥80



N307

LED retrofit

PAR16

PAR20

IP54

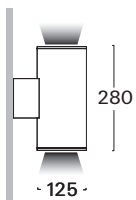
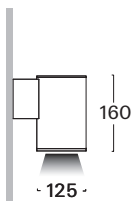

100





S602



LED plate

18 W **2610** lm
24 W **3730** lm

CCT 3000 / **4000** / 5000 K
CRI **≥80** / ≥90



S604

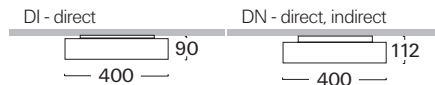

LED plate

36 W **5600** lm
47 W **7260** lm

CCT 3000 / **4000** / 5000 K
CRI **≥80** / ≥90

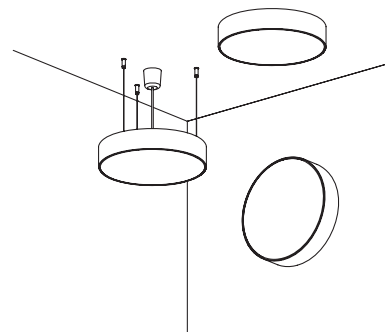

A3





S614

DI - direct

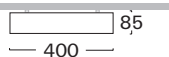

DN - direct, indirect

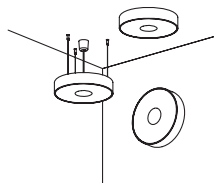
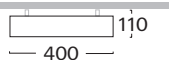

LED plate

20 W **3230** lm

28 W **4270** lm

40 W **5740** lm

CCT 3000 / **4000** / 5000 K

CRI **≥80** / ≥90



A3





F604

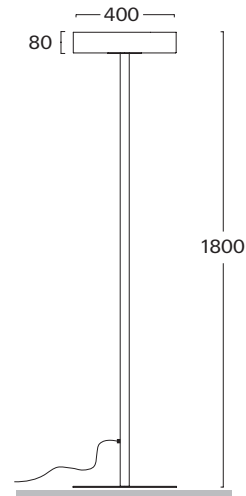

LED plate

20 W **3230** lm

28 W **4270** lm

40 W **5740** lm

CCT 3000 / **4000** / 5000 K

CRI **≥80** / ≥90



ám na vašej spokojnosti.
Ďakujeme za vašu dôveru. **Vitajte!**
eme vašim investíciám rásť. **Záleží nám** na vašej spokojnosti





S606

LED plate

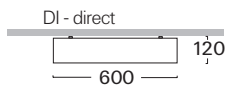

40 W **6000** lm
60 W **9160** lm

CCT 3000 / **4000** / 5000 K
CRI **≥80** / ≥90

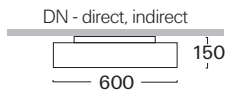

S609

LED plate

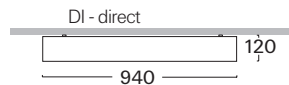

80 W **12800** lm
136 W **20920** lm

CCT 3000 / **4000** / 5000 K
CRI **≥80** / ≥90

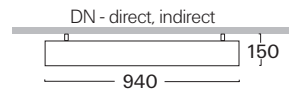

A3



Which KFC restaurant
do you know you
are going to visit?
Drums
are
fresh throu
tasting, blessed an
from the restaurant
is eating Origin
hence H T and Spicy
get in Malay sia or Do
n, you know the qua
lity of our domestic
the
0000000 Goodood.

Z646

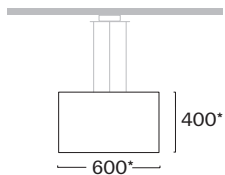

LED plate

20 W **3230** lm
28 W **4270** lm
40 W **5740** lm

CCT 3000 / **4000** / 5000 K
CRI **≥80** / ≥90



LED retrofit

E27



Z648

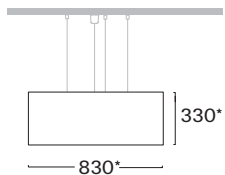

číslo folie
the film no.

30



05



07



02



35

* jiný rozměr možný
* another size possible

Do folie je možné vyřezat logo, text nebo grafiku na přání.
Logo, lettering or graphics can be cut in the foil on order.





VITA SANA CLUB
FITNESS LIFESTYLE

Z688

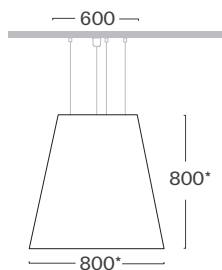

LED plate

20 W **3230** lm

28 W **4270** lm

40 W **5740** lm

CCT 3000 / **4000** / 5000 K

CRI **≥80** / ≥90



LED retrofit

E27

Z686

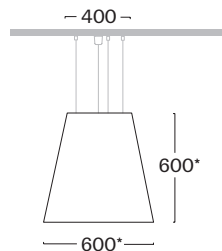

číslo folie
the film no.

05

02

07

* jiný rozměr možný
* another size possible







Z810

LED retrofit

E27

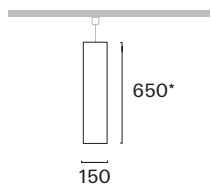

05



15



32



20



36



06



07

* jiný rozměr možný
* another size possible

číslo folie
the film no.

02



Z821

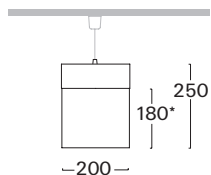

LED cob

10 W	1450 lm
14 W	2000 lm
20 W	2650 lm
29 W	3600 lm
37 W	4300 lm
43 W	5000 lm

CCT 3000 / **4000** / 5000 K

CRI **≥80** / ≥90



* větší rozměr možný

* bigger size possible







V821

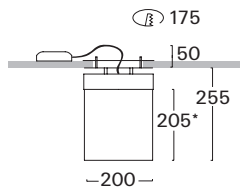

LED cob

10 W	1450 lm
14 W	2000 lm
20 W	2650 lm
29 W	3600 lm
37 W	4300 lm
43 W	5000 lm

CCT 3000 / **4000** / 5000 K
CRI **≥80** / ≥90



- * větší rozměr možný
- * bigger size possible



Z812

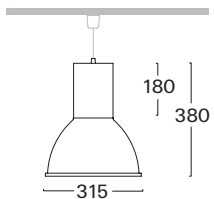

LED cob

10 W	1450 lm
14 W	2000 lm
20 W	2650 lm
29 W	3600 lm
37 W	4300 lm
43 W	5000 lm

CCT 3000 / **4000** / 5000 K
CRI **≥80** / ≥90

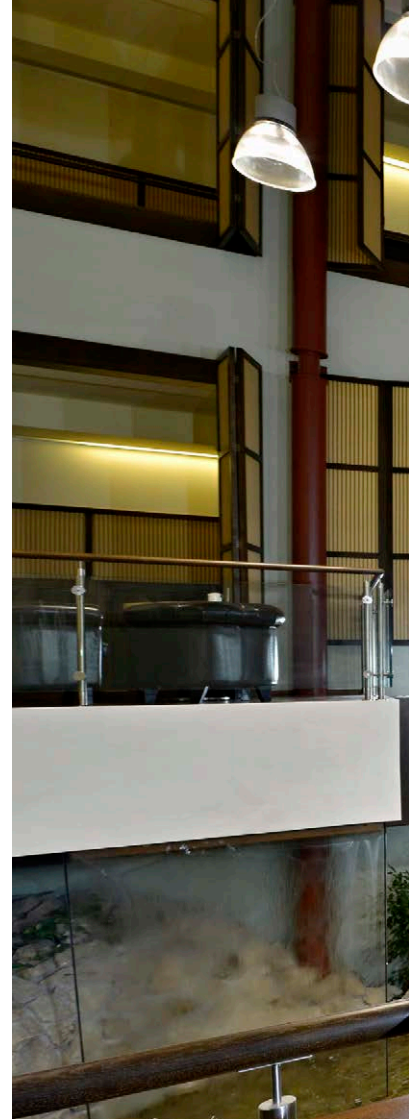





Pilsner Urquell

Z822

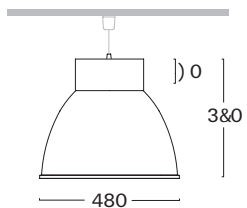

LED cob

14 W **2000** lm
20 W **2650** lm
29 W **3600** lm
37 W **4300** lm
43 W **5000** lm

CCT 3000 / **4000** / 5000 K
CRI **≥80** / ≥90



V130

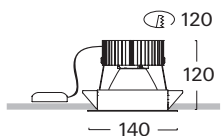

LED cob

10 W	1450 lm
14 W	2000 lm
20 W	2650 lm
29 W	3600 lm

DIM

LED cob AC

9 W	800 lm
-----	---------------

∠ SP / MD / FL / WF
CCT 2700 / 3000 / **4000** K
CRI **≥80** / ≥90



V131

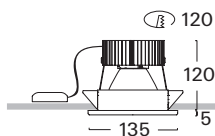

∠ WF





V131

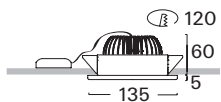

LED COIN 111

20 W **1560** lm
25 W **2500** lm
37 W **3780** lm

DIM

LED COIN 111 AC

16 W **1350** lm
23 W **1950** lm

∠ 24° / 40°
CCT 2700 / 3000 / **4000** K
CRI **≥80** / ≥90

V130

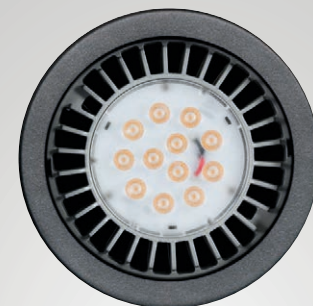
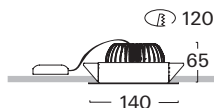



V130

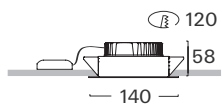

LED cob

10 W **1450** lm

14 W **2000** lm

20 W **2650** lm

CCT 3000 / **4000** / 5000 K

CRI **≥80** / ≥90



V131

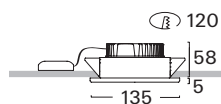

P1



A3

V170

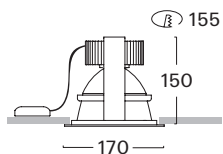

LED cob

10 W	1450 lm
14 W	2000 lm
20 W	2650 lm
29 W	3600 lm
37 W	4300 lm
43 W	5000 lm

CCT 3000 / **4000** / 5000 K
CRI **≥80** / ≥90

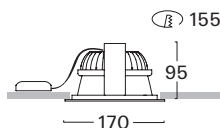

LED COIN 111

20 W	1560 lm
25 W	2500 lm
37 W	3780 lm

DIM

LED COIN 111 AC

16 W	1350 lm
23 W	1950 lm

◁ 24° / 40°
CCT 2700 / 3000 / **4000** K
CRI **≥80** / ≥90



HD





V213

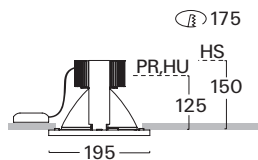

LED cob

10 W	1450 lm
14 W	2000 lm
20 W	2650 lm
29 W	3600 lm
37 W	4300 lm
43 W	5000 lm
51 W	5800 lm

CCT 3000 / **4000** / 5000 K
CRI **≥80** / ≥90



HS



HU





S218

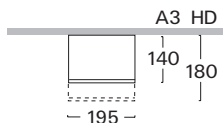

LED plate

7 W	940 lm
10 W	1310 lm
14 W	1790 lm
20 W	2480 lm

CCT 3000 / **4000** / 5000 K
CRI **≥80** / ≥90



A3



V218

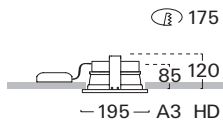

LED plate

7 W	940 lm
10 W	1310 lm
14 W	1790 lm
20 W	2480 lm

CCT 3000 / **4000** / 5000 K
CRI **≥80** / ≥90



HD



V299

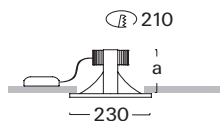
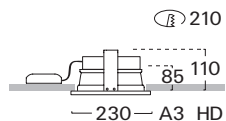

LED plate

10 W	1310 lm
14 W	1790 lm
20 W	2480 lm
26 W	3490 lm

CCT 3000 / **4000** / 5000 K
 CRI **≥80** / ≥90



LED cob

10 W	1450 lm	125 (a)
14 W	2000 lm	125 (a)
20 W	2650 lm	125 (a)
29 W	3600 lm	125 (a)
37 W	4300 lm	125 (a)
43 W	5000 lm	125 (a)
51 W	5800 lm	135 (a)



S299

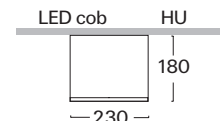
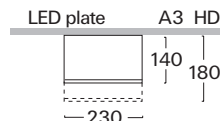

* max. 29 W





V274

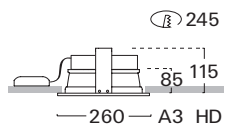

LED plate

14 W	1790 lm
20 W	2480 lm
26 W	3490 lm
32 W	5030 lm

CCT 3000 / **4000** / 5000 K
CRI **≥80** / ≥90

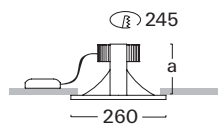

LED cob

14 W	2000 lm	140 (a)
20 W	2650 lm	140 (a)
29 W	3600 lm	140 (a)
37 W	4300 lm	140 (a)
43 W	5000 lm	140 (a)
51 W	5800 lm	150 (a)



HD



S274

LED plate

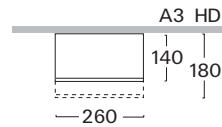

14 W **1790** lm

20 W **2480** lm

26 W **3490** lm

32 W **5030** lm

CCT 3000 / **4000** / 5000 K

CRI **≥80** / ≥90



A3

V159

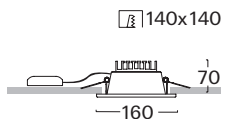

LED cob

10 W **1450** lm
14 W **2000** lm
20 W **2650** lm

CCT 3000 / **4000** / 5000 K
CRI **≥80** / ≥90



V189

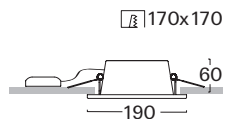

LED plate

7 W **940** lm
10 W **1310** lm
14 W **1790** lm
20 W **2480** lm

CCT 3000 / **4000** / 5000 K
CRI **≥80** / ≥90



A3



ПРОСНИТЕ
СВОЕ ВКУСНОЕ
ИДЕАЛЬНОЕ



V160

LED cob

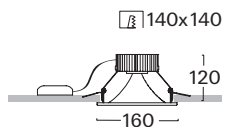

10 W	1450 lm
14 W	2000 lm
20 W	2650 lm
29 W	3600 lm
37 W	4300 lm

CCT 3000 / **4000** / 5000 K
CRI **≥80** / ≥90



V190

LED cob

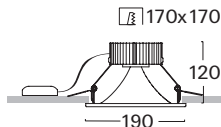

10 W	1450 lm
14 W	2000 lm
20 W	2650 lm
29 W	3600 lm
37 W	4300 lm
43 W	5000 lm

CCT 3000 / **4000** / 5000 K
CRI **≥80** / ≥90



MU



HU

V161

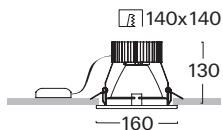

LED cob

10 W	1450 lm
14 W	2000 lm
20 W	2650 lm
29 W	3600 lm
37 W	4300 lm

∠ SP / MD / FL / WF
CCT 3000 / **4000** / 5000 K
CRI **≥80** / ≥90

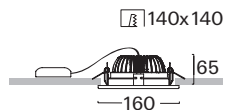

LED COIN 111

20 W	1560 lm
25 W	2500 lm
37 W	3780 lm

∠ 24° / 40°
CCT 2700 / 3000 / **4000** K
CRI **≥80** / ≥90



LED COIN 111 AC

16 W	1350 lm
23 W	1950 lm



∠ FL





V181

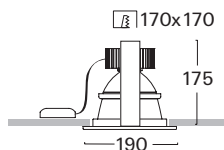

LED cob

10 W	1450 lm
14 W	2000 lm
20 W	2650 lm
29 W	3600 lm
37 W	4300 lm

CCT 3000 / **4000** / 5000 K

CRI **≥80** / ≥90



HD

LED COIN 111

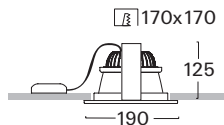

20 W	1560 lm
25 W	2500 lm
37 W	3780 lm

DIM

LED COIN 111 AC

16 W	1350 lm
23 W	1950 lm

∠ 24° / 40°

CCT 2700 / 3000 / **4000** K

CRI **≥80** / ≥90





V225

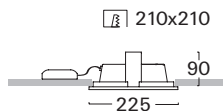

LEDplate

20 W **2930** lm

26 W **3950** lm

CCT 3000 / **4000** / 5000 K

CRI **≥80** / ≥90



V277

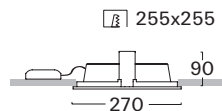

LED plate

26 W **3950** lm

32 W **5030** lm

CCT 3000 / **4000** / 5000 K

CRI **≥80** / ≥90



A3

S300

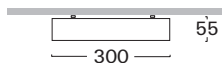

LED plate

20 W **2930** lm

26 W **3950** lm

CCT 3000 / **4000** / 5000 K

CRI **≥80** / ≥90



S400

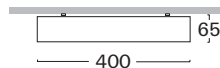

LED plate

28 W **4270** lm

40 W **5740** lm

CCT 3000 / **4000** / 5000 K

CRI **≥80** / ≥90



A3





N225

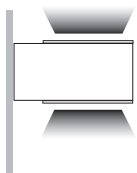
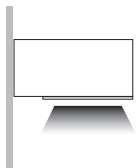
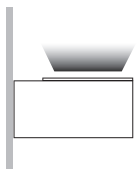
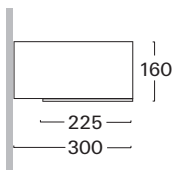

LED plate

20 W **2930** lm

26 W **3950** lm

CCT 3000 / **4000** / 5000 K

CRI **≥80** / ≥90



N277

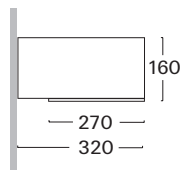

LED plate

26 W **3950** lm

32 W **5030** lm

CCT 3000 / **4000** / 5000 K

CRI **≥80** / ≥90



A3

S225

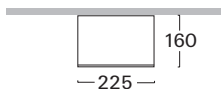

LED plate

20 W **2930** lm

26 W **3950** lm

CCT 3000 / **4000** / 5000 K

CRI **≥80** / ≥90



S277

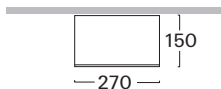

LED plate

26 W **3950** lm

32 W **5030** lm

CCT 3000 / **4000** / 5000 K

CRI **≥80** / ≥90





S160

LED cob

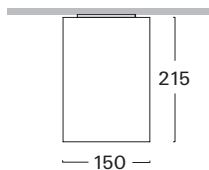

10 W	1450 lm
14 W	2000 lm
20 W	2650 lm
29 W	3600 lm
37 W	4300 lm

CCT 3000 / **4000** / 5000 K

CRI **≥80** / ≥90

DIM HU MU



HU

MU

S416

LED COIN 111

20 W **1560** lm
25 W **2500** lm
37 W **3780** lm

LED COIN 111 AC

16 W **1350** lm
23 W **1950** lm

∠ 24° / 40°
CCT 2700 / 3000 / **4000** K
CRI **≥80** / ≥90

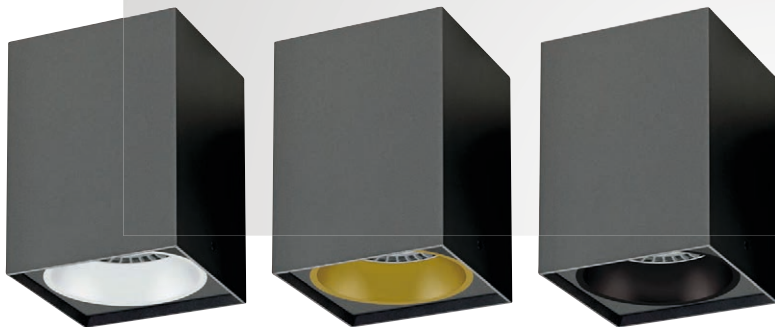
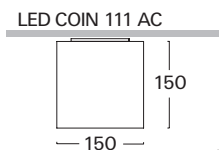
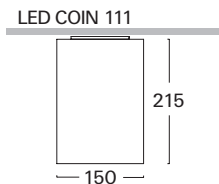



S481

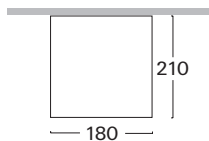

LED cob

10 W **1450** lm

14 W **2000** lm

20 W **2650** lm

29 W **3600** lm

CCT 3000 / **4000** / 5000 K

CRI **≥80** / ≥90



PR



HS

V595

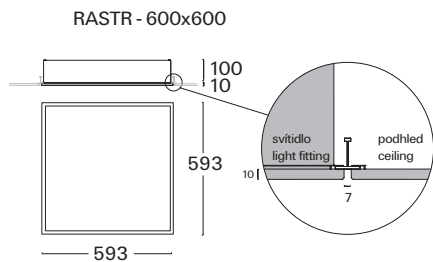

LED plate

34 W **4500** lm

32 W **5230** lm

48 W **7540** lm

CCT 3000 / **4000** / 5000 K

CRI **≥80** / ≥90

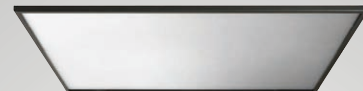

M3

V600

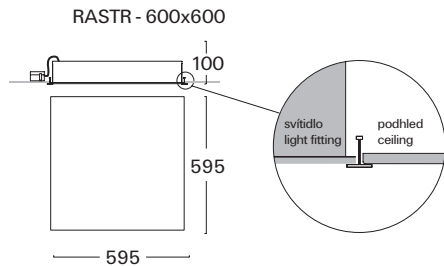

V625

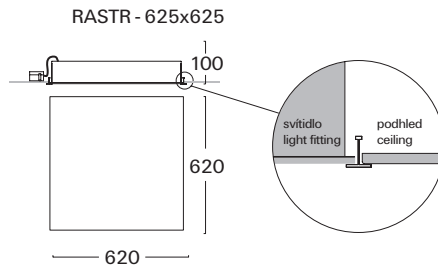



Speciální LED cob zdroje / Special LED cob sources

Osvětlení prodejních ploch by mělo vytvářet příjemnou atmosféru pro zákazníky a při správné volbě typu osvětlení také zdůraznit nabízené zboží. Kromě kvalitních svítidel je tedy nutné zvolit vhodný typ světelného zdroje. Současná LED technologie nabízí i speciální zdroje pro konkrétní produkty ke zvýraznění jejich přirozené barvy.

Illumination of business premises should create a pleasant atmosphere for customers and with the right choice of luminaires highlight offered products as well. Apart from the quality luminaires it is therefore necessary to use an appropriate light source. LED technology currently offers special light sources for specific goods to enhance their natural colour.

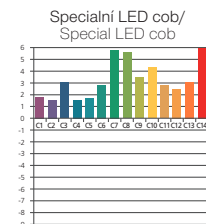
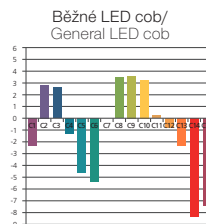

Syté barvy a čistá bílá / Rich colours and clear white

Barvy produktů jsou kontrastní, živější a saturovanější. Bílá je jasná a čistá, bez žlutého podtónu. Vysoké podání barev (CRI>95), bez UV složky - vhodné pro použití v oblasti maloobchodu a zejména módy a odívání.

Colours of products are more vivid, saturated and contrasting. White colour is bright and clear without any yellow undertones. High colour rendering index value is maintained (CRI>95). Without UV compound - matching for use in shops and in the field of clothing and fashion.

Věrné podání barev / Real colours

Zdroje s vysokým podáním barev CRI>97 - pro věrné zobrazení barev, vhodné pro použití v galeriích a muzeích.

Sources with high colour rendering index CRI>97 - for accurate rendering of colours, suitable for use in galleries and museums.

Pro potraviny / For food

Potravinové zdroje pro maso, pečivo, ryby a zeleninu. Zvyšují atraktivitu a čerstvost vystaveného zboží. Díky speciálnímu zdroji není potřeba kupovat ke svítidlu další filtry, což snižuje pořizovací náklady.

Food sources for meat, pastry, fish and vegetables. They increase the attractiveness and freshness of displayed products. There is no need to buy additional filters, thanks to this special LED source, which reduces initial costs.



Tunable white

Umožňuje libovolné střídání mezi teplou a studenou bílou barvou světla i změnu jeho intenzity. Díky tomu je možné napodobovat přirozené světelné podmínky venkovního prostředí, kde se barevná teplota spolu s intenzitou světla během dne mění. Tento způsob osvětlování příznivě ovlivňuje pocit pohody a produktivitu osob v prostorách s umělým osvětlením např. v kancelářích, školách nebo nemocnicích.

Enables mixing between warm and cold white as well as change of luminous intensity. This helps replicate outdoor light conditions, where light colour and intensity changes throughout the day. This way of illuminating positively affects productivity and the well-being of persons in artificially-illuminated areas like offices, schools or hospitals.

Ochranná skla a filtry / Cover glass and filters

Prisma

Prisma

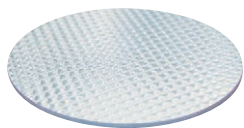

P1

P1 akrylátová prisma čirá/
acrylic prisma clear

Ochranné tvrzené sklo

Tempered cover glass



T1 T3

T1 tvrzené sklo čirá/
tempered glass clear
T3 tvrzené sklo opálové/
tempered glass opal

Prismatická skla kryjí světelný zdroj a zajišťují optimální distribuci světelného toku. Opálová mikroprisma vytváří jemné difuzní světlo, omezuje oslnění a je tak vhodná pro kancelářské prostory.

Prismatic glass covers the light source and ensures optimal light distribution. Opal microprisma creates soft diffused light, reduces glare and is therefore suitable for office space.

Skla slouží pro ochranu světelného zdroje. Opálové sklo rozptyluje světelný tok rovnoměrně do všech směrů, omezuje odlesky a vytváří jemné difuzní světlo.

Glass is used for protection of light source. Opal glass diffuses light evenly in all directions, reducing glare and creating a soft diffused light.

Mikroprisma

Microprisma



M3

M3 akrylátová mikroprisma opálová/
acrylic microprisma opal

Akrylátové sklo

Acrylic glass



A1 A3

A1 akrylátové sklo čirá/
acrylic glass clear
A3 akrylátové sklo opálové/
acrylic glass opal

Příslušenství / Accessories

Filtr pro eliptickou distribuci světelného toku

Linear spread lens



Vytváří světelný tok s oválnou charakteristikou. Vhodné pro použití s reflektorem spot.

Creates beam of light with oval characteristics. Suitable for use with spot reflector.



Komínek

Snoot



Účinně zamezuje oslnění a vytváří homogenní proud světla s ostrým okrajem. Vhodný pro nasvícení detailů. Pouze pro použití s reflektorem spot.

Effectively reduces glare and creates a contrasting beam of light with a sharp edge. Ideal for spotlighting details. Suitable only for use with spot reflector.



Voštinový filtr

Honeycomb filter



Usměrňuje světelný tok, zvyšuje jeho homogenitu a omezuje oslnění.

Directs the luminous flux and cultivates the uniformity of light. It is used for prevention of light spill.



Příslušenství / Accessories



Zalévací pouzdro do betonu/
Mounting box for concrete

Montážní box do fasádní izolace/
Installation box for facade isolation

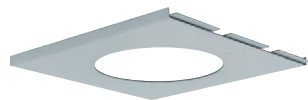

Montážní kazeta
pro lamelové podhledy/
Assembly cassette
for lamella ceiling



Zpevňující kazeta
pro měkké minerální podhledy/
Strengthening cassette
for soft mineral ceiling



Zalévací pouzdro do betonu/
Mounting box for concrete

Montážní box do fasádní izolace/
Installation box for facade isolation



Montážní příslušenství
pro podhledy z hliníkových mřížek/
Assembly accessories
for ceiling from aluminium grids



Adaptační kroužky
pro redukci montážního otvoru/
Adaptor rings
for reduction of mounting hole



**Pevný závěs s kabelem uvnitř/
Fixed suspension with cable inside**



**Kompaktní třílankový stavitelný závěs/
Compact three-string adjustable suspension**



**Kompaktní čtyřlankový stavitelný závěs/
Compact four-string adjustable suspension**



**Čtyřlankový stavitelný závěs/
Four-string adjustable suspension**



**Jednolankový stavitelný závěs do lišty/
Adjustable single suspension for feeding tracks**



**Pevný závěs do lišty/
Fixed suspension for feeding tracks**

Barvy a povrchy / Colours and finishes



W1
bílá lesk *
white gloss *



B1
černá lesk *
black gloss *

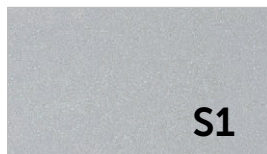

S1
stříbrná lesk
silver gloss

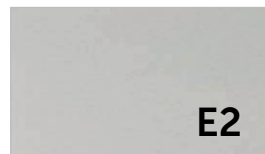

E2
elox mat
anodised aluminium matt

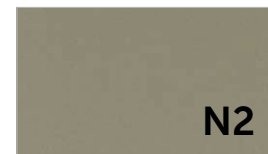

N2
nikl mat
nickel matt

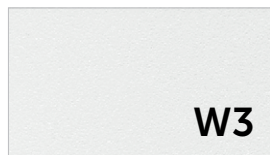

W3
bílá struktura *
white sand *



B3
černá struktura *
black sand *

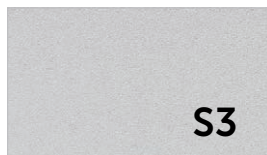

S3
stříbrná struktura
silver sand



H3
antracit struktura světlá *
anthracite sand light *



D3
antracit struktura tmavá *
anthracite sand light *



G1
zlatá
gold

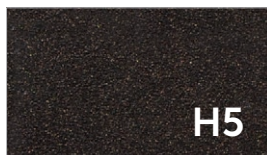

H5
hnědá rustikální struktura *
rustic brown sand *



S9
stříbrná struktura *
silver sand *



Z3
malachit struktura *
malachite sand *



jiné barvy dle RAL
other RAL colours

Barvy folií / Colours of polymeric film



Metalická / Metallic

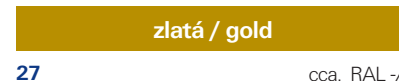

3-Fázový lištový systém / 3-Phase track system

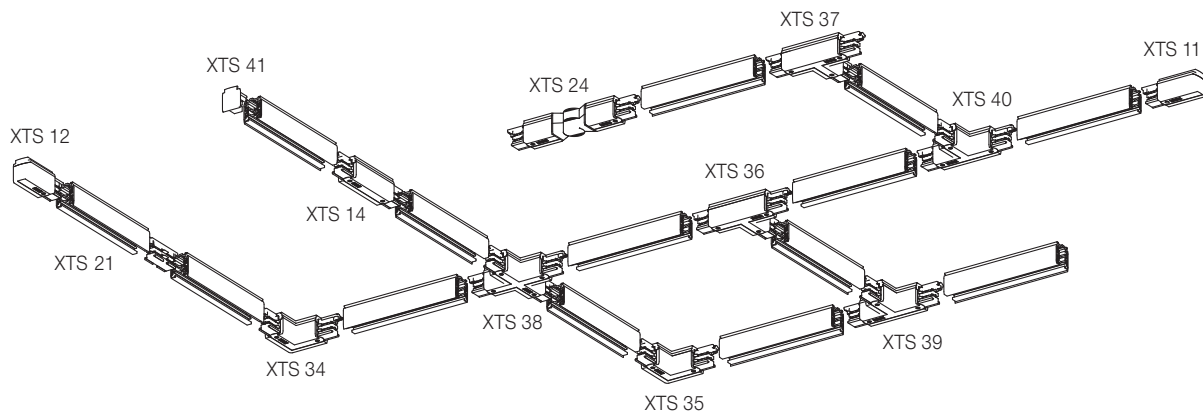

XTS - závěsná verze / suspension version

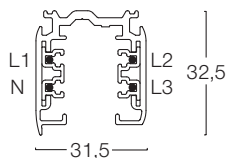

XTSF - vestavná verze / recessed version

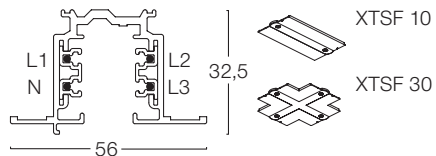

Půdorys / plan

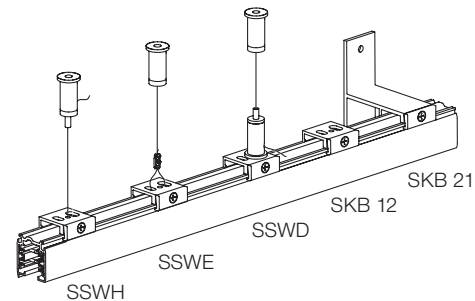
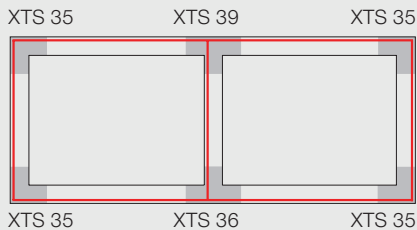

Stmívatelný lištový systém / Dimmable track system

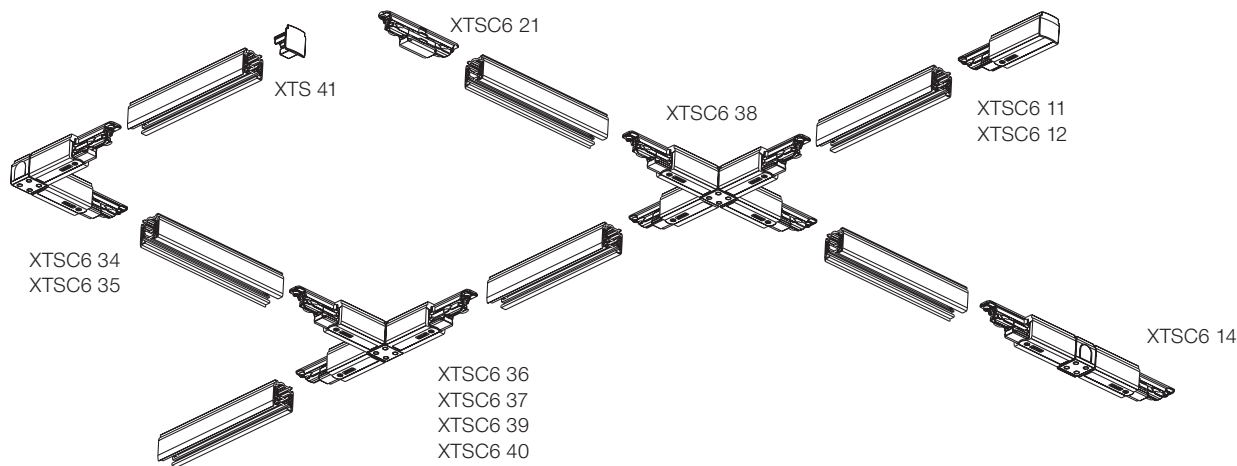



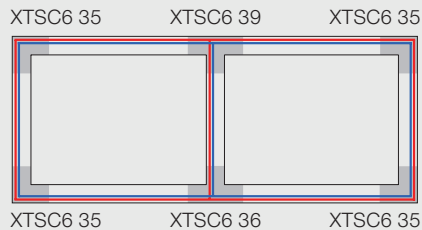
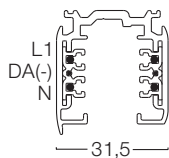

XTSC - závěsná verze
/ suspension version

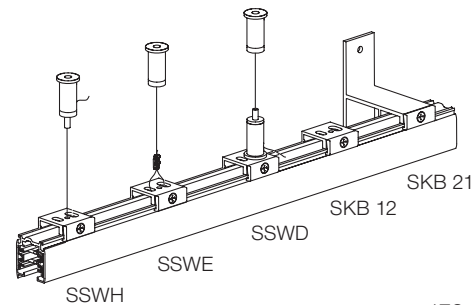

Půdorys / plan



Vysvětlivky / Explanation of symbols

 Reflektor PR - matný Reflector PR - matt	 Akrylátový difuzor - opál Acrylic diffuser – opal	 Nouzové provedení Emergency version
 Reflektor HS - lesklý Reflector HS - specular	 Prismatický difuzor - čirý Prismatic diffuser - clear	 Závěs Suspension
 Reflektor HD - lesklý Reflector HD - specular	 Mikroprismatický difuzor - opál Microprismatic diffuser - opal	 Nástěnný držák Wall holder
 Reflektor HU - hladký UGR < 19 Reflector HU - smooth UGR < 19	 Filtr pro eliptickou distribuci Linear spread lens	 Přímá montáž na zeď Direct mounting on the wall
 Reflektor MU - matný UGR < 19 Reflector MU - matt UGR < 19	 Voštinový filtr Honeycomb filter	
 Úhel vyzařování reflektoru Beam angle of reflector	 Komínek Snoot	
 Spot - úhel vyzařování 10-20° Spot - beam angle 10-20°	 Volitelná barva fólie Optional colour of polymeric film	
 Medium - úhel vyzařování 21-34° Medium - beam angle 21-34°	 Stmívatelné provedení Dimmable version	
 Flood - úhel vyzařování 35-49° Flood - beam angle 35-49°	 Zvýšený stupeň krytí - IP54 Higher degree of protection - IP54	
 Wide flood - úhel vyzařování ≥ 50° Wide flood - beam angle ≥ 50°	 Stupeň krytí může být zvýšen přidáním doplňku (skla, krytu, těsnění...). Vestavná svítidla zabudovaná v uzavřených stropích, mají zvýšený stupeň krytí v části pod podhledem.	
 Doplňková skla / filtry Additional glass / filters	<p>The degree of protection (IP) can be increased with complements (glass, cover, gasket...). The luminaires which are installed in the closed ceiling have higher degree of protection in the part under the ceiling.</p>	

LED cob	Multičip Multi LED chips	CCT (Tc)	Teplota chromatičnosti Correlated color temperature
LED cob AC	Multičip na 230V Multi LED chip for 230V	CRI (Ra)	Index podání barev Colour rendering index
LED plate	SMD LED panel SMD LED board	60/77	Rozměry v milimetrech Dimensions in millimeters
LED retrofit	LED světelné zdroje LED retrofit lamps		Třída energetické účinnosti svítidel (s LEDplate a LEDcob) Energy efficiency class fixtures (with LEDplate and LEDcob)
LED coin 111	LED modul s optikou LED module with optics		
LED coin 111 AC	LED modul s optikou na 230V LED module with optics for 230V		
LED coin 50	LED modul s optikou LED module with optics		
LED coin 50 AC	LED modul s optikou na 230V LED module with optics for 230V		









PAN MOJ AVOH MOJ

6
1900 – 1993

Hermína Týrlová

— Životní příběh / Her life story

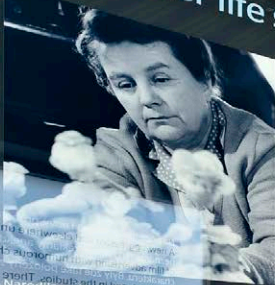

Narodila se 11. 12. 1900 v Brezových Horách z rodiny výrazně kulturního otce a učitelky Marie Dodákové. Po svém otci, který lidových básněm, zrodila výrazný výtvarný talent. Pokoušela se uplatnit jako baletka a herečka, poté nastoupila jako ilustrátorka dětských časopisů. Statice ilustrace však neodpovídaly jejím tvůrčím představám. Své zájmy poprvé naplnila v kreslířském atelieru společnosti Elektastrum, kde pracovala pod vedením jejího otce a učitelky Marie Dodákové. Pojila své první zkušenosti jako animátorka v roce 1940. Zimským filmářům ji doporučil historik filmových žánrů, prvního filmového festivalu v Praze, Karel Smrč, který zasedal v porotě zilmových filmových žánrů, prvního filmového festivalu v Praze. Ve Zlíně Týrlová od roku 1941 po 17 měsíců natáčela první český loutkový film *Ferdá mravovec* podle námětu Ondřeje Sekora. O kombinaci žánrů. Na filmu spolupracovali s Břetislavem Zemanem. Téměř hotový film pokoušela ve Vánočním snu. Téměř hotový film však byl zničen při požáru atelieru ve zářivčinnosti. Přetvoření filmu se však Týrlová ve zřetelnosti dovedla nezářivčinnosti. Záměr natočit kombinovaný film zopakovala ve filmu *Vzpouřila hrdinůždních* 1946, za který získala ocenění na Bruselských filmových festivalech v Benátkách a Bruselu a do dnes se těší přízni dětí i dospělých.



1946
Hermína Týrlová před kamerou při natáčení filmu *Recvi of the Fox*.

Hermína Týrlová was born on December 11th 1900 in Brezová Hora near Přibram. She inherited a distinctive artistic talent after her father, a composer of folk-musical scenes, she moved to Prague, worked as a singer, dancing, musician and then as an actress. Before long she had started as an illustrator of children's magazines. However, these however did not perfectly suit her creative purposes. Her real intentions were realised for the first time when she worked under the guidance of as the first time when working on advertising film about rubber toys Elephant Annie. Assistant director Karel Dodák who would later become an animator and painter. In 1934 she encountered Zin film for the first time when working on advertising film about rubber toys Elephant Annie. Assistant director Karel Dodák's second partner, until her emigration to the United States in 1938.



1943
Upon her return in 1940 Hermína joined the film studio of Karel Smrč. Film historian Karel Smrč had recommended her to the Zin film-makers after seeing her work when sitting on the jury of the Zin '94 Harvest', the first film festival in the country. From 1941 at Zin, Týrlová worked on her first feature for 17 long months (during the first Czech paper film *Ferdá the Ant* 1941) a story by Ondřej Sekora.

Next up Týrlová collaborated with Soviet and Czech paper film *Ferdá the Ant* 1941) a story by Ondřej Sekora. Karel Zeman was a project which introduced an innovative combination and background. He made an animated cartoon, however, almost never made a Christmas Dream. The negatives were destroyed in a fire at the editing table in February 1944. Karel Zeman then undertook to remake the film from scratch. Unfortunately due to the war Týrlová was not able to participate. However, she was able to return and complete a second film with Zeman namely *Recvi of the Fox* 1946, which won awards at international film festivals in Venice and Brussels and is still a favourite for children and adults alike.

FILMOGRAFIE / FILMOGRAPHY

Rok	Název filmu	Režisér
1934	Elephant Annie	Karel Dodák
1941	Ferdá mravovec	Ondřej Sekora
1946	Recvi of the Fox	Karel Zeman
1947	Vánoční sen	Břetislav Zeman
1948	Vzpouřila hrdinůždních	Břetislav Zeman
1949	Želva	Břetislav Zeman
1950	Čarodějnice	Břetislav Zeman
1951	Čarodějnice	Břetislav Zeman
1952	Čarodějnice	Břetislav Zeman
1953	Čarodějnice	Břetislav Zeman
1954	Čarodějnice	Břetislav Zeman
1955	Čarodějnice	Břetislav Zeman
1956	Čarodějnice	Břetislav Zeman
1957	Čarodějnice	Břetislav Zeman
1958	Čarodějnice	Břetislav Zeman
1959	Čarodějnice	Břetislav Zeman
1960	Čarodějnice	Břetislav Zeman
1961	Čarodějnice	Břetislav Zeman
1962	Čarodějnice	Břetislav Zeman
1963	Čarodějnice	Břetislav Zeman
1964	Čarodějnice	Břetislav Zeman
1965	Čarodějnice	Břetislav Zeman
1966	Čarodějnice	Břetislav Zeman
1967	Čarodějnice	Břetislav Zeman
1968	Čarodějnice	Břetislav Zeman
1969	Čarodějnice	Břetislav Zeman
1970	Čarodějnice	Břetislav Zeman



1946
Hermína Týrlová před kamerou při natáčení filmu *Recvi of the Fox*.





FILMOVÉ ŽNĚ / THE FILM HARVEST

Success of Žižka Filmmakers and Czech Film Festival



Textual information on the right wall display.













Naše svítidla byla použita pro osvětlení expozice firmy Preciosa Lighting na veletrhu Euroluca 2017 v Miláně a také pro osvětlení interiéru jejich vlajkového obchodu v Praze.

Autoři expozice / interiéru: Vasku & Klug
Klient: Preciosa Lighting

Our luminaires were used for illuminating the Preciosa Lighting company's exhibition stand on Euroluca International Fair 2017 in Milano as well as for illumination of the company's flagship store interior in Prague.

Authors of the exhibition / interior: Vasku & Klug
Client: Preciosa Lighting











200 GRANDES
C.A.V.A

ESPIRIT

Azafrán

Marinera

Paeller

JOSÉ LITO

JOSÉ LITO

ENRTE

Rejstřík / Index

D

D135	17
D313	37
D314	21
D315	27

F

F604	106
------	-----

L

L135	14
L305	41
L313	36
L314	18
L315	24
L316	35
L510	70
L511	73

N

N225	155
N277	155
N307	100
N315	28 - 31
N415	58 - 59
N493	63
N510	68

N800	87 - 89
N801	95
N802	99

S

S135	14
S160	158
S218	137
S225	156
S274	141
S277	156
S299	138
S300	152
S305	45
S313	38
S314	23
S315	24
S316	32
S400	152
S415	57
S416	159
S481	161
S510	67
S602	102
S604	102
S606	109
S609	109

S614	105
S800	83 - 84
S801	91
S802	97

V

V130	126 - 131
V131	126 - 131
V135	16
V159	142
V160	145
V161	146
V170	132
V181	149
V189	142
V190	145
V191	50 - 53
V192	50 - 53
V193	50 - 53
V194	50 - 53
V213	134
V218	137
V225	151
V274	140
V277	151
V299	138
V313	37

V314	22
V315	26
V595	162
V600	162
V625	162
V718	49
V755	46
V821	121

Z

Z492	60
Z493	60
Z494	60
Z510	66
Z520	65
Z646	111
Z648	111
Z686	114
Z688	114
Z800	82 - 84
Z801	91
Z802	97
Z803	78 - 79
Z804	78 - 79
Z805	80
Z810	117
Z812	122

Z821	118
Z822	125
Z832	76
Z833	75
Z834	76



blízkosť
s
úrovňami

ku každému sme rovnako blízko.
prístupujeme ku všetkým úrovňom.

na nás sa môžete spoľahnúť.
sme tím, ktorý...

deos



více informací
more information